

### True Multi-Touch Capacitive Touch Panel Controller

#### INTRODUCTION

The FT5336GQQ is single-chip capacitive touch panel controller ICs with a built-in enhanced Micro-controller unit (MCU). It adopts the mutual capacitance and full screen common mode scan technology. Being coupled with a mutual capacitive touch panel, the FT5336GQQ implements the user-friendly inputting function and be widely used in various portable devices, such as smart phones, tablets, MIDs and GPS .

#### FEATURES

- Mutual Capacitive Sensing Techniques
- Full Screen Common Mode Scan Techniques
- Supports up to 13 TX Lines + 24 RX Lines
- Supports up to 6.1" Touch Screen
- High Report Rate: Up to 120Hz
- Fully Programmable Scan Sequences to Support Various TX/RX Configurations
- Proximity modes detection:
  - Air Swipe
  - Glove Usage
  - Cheek check
- Immune to RF Interferences
- True Multi-touch with up to 5 Points
- Touch Resolution of 100 Dots per Inch (dpi) or above -- depending on the Panel Size
- Auto-calibration
- Support Interfaces :I2C
- 2.8V to 3.3V Operating Voltage
- IOVCC Supports from 1.8V or VDD3
- Capable of Driving Single Channel (transmit/receive) Resistance: Up to 30K  $\Omega$
- Capable of Supporting Single Channel (transmit/receive) Capacitance: 60 pF
- Optimal Sensing Mutual Capacitor: 1pF~3pF
- 12-Bit ADC Accuracy
- Built-in Enhanced MCU
- Built-in LDO for Digital Circuits
- 3 Operating Modes
  - Active
  - Monitor
  - Hibernate
- Operating Temperature Range: -40°C to +85°C

# TABLE OF CONTENTS

INTRODUCTION .....	I
FEATURES.....	I
1 OVERVIEW .....	3
1.1 TYPICAL APPLICATIONS .....	3
2 FUNCTIONAL DESCRIPTION .....	3
2.1 ARCHITECTURAL OVERVIEW .....	3
2.2 MCU .....	4
2.3 OPERATION MODES .....	4
2.4 HOST INTERFACE.....	4
2.5 SERIAL INTERFACE .....	5
2.6 PROXIMITY MODES .....	6
3 ELECTRICAL SPECIFICATIONS.....	7
3.1 ABSOLUTE MAXIMUM RATINGS .....	7
3.2 DC CHARACTERISTICS .....	7
3.3 AC CHARACTERISTICS .....	7
3.4 I/O PORTS CIRCUITS .....	8
3.5 POWER ON/RESET SEQUENCE .....	9
4 PIN CONFIGURATIONS .....	10
5 PACKAGE INFORMATION .....	12
5.1 PACKAGE INFORMATION OF QFN-5X5-48L PACKAGE .....	12
5.2 ORDER INFORMATION.....	13

THIS DOCUMENT CONTAINS INFORMATION PROPRIETARY TO FOCALTECH SYSTEMS CO.,LTD., AND MAY NOT BE REPRODUCED, DISCLOSED OR USED IN WHOLE OR PART WITHOUT THE EXPRESS WRITTEN PERMISSION OF FOCALTECH SYSTEMS CO.,LTD.

# 1 OVERVIEW

## 1.1 Typical Applications

FT5336GQQ accommodates a wide range of applications with a set of buttons up to a 2D touch sensing device; their typical applications are listed below.

- Mobile phones
- Tablets
- MIDs
- Navigation systems, GPS
- Game consoles
- POS (Point of Sales) devices
- Portable MP3 and MP4 media players
- Digital cameras

FT5336GQQ support  $\leq 6.1''$  Touch Panel, the spec is listed in the following table,

Model Name	Panel		Package			Touch Panel Size	Typical Pitch
	TX	RX	Type	Pin	Size		
FT5336GQQ	13	24	QFN5*5	48	0.6-P0.35	$\leq 6.1''$	~5mm

Remarks: FocalTech suggests using pitch between 4.0mm to 6.0mm; The customer can decide the pitch based on applications.

# 2 FUNCTIONAL DESCRIPTION

## 2.1 Architectural Overview

Figure2-1 shows the overall architecture for the FT5336GQQ.

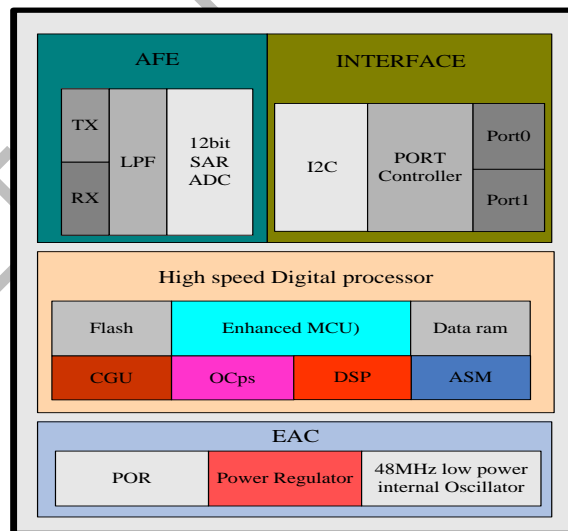

Figure 2-1 FT5336GQQ System Architecture Diagram

The FT5336GQQ is comprised of five main functional parts listed below,

- Touch Panel Interface Circuits

The main function for the AFE and AFE controller is to interface with the touch panel. It scans the panel by sending AC signals to the panel and processes the received signals from the panel. It includes both Transmit (TX) and Receive (RX) functions. Key parameters to configure this circuit can be sent via serial interfaces.

- Enhanced MCU with DSP accelerator

**HIS DOCUMENT CONTAINS INFORMATION PROPRIETARY TO FOCALTECH SYSTEMS CO.,LTD., AND MAY NOT BE REPRODUCED, DISCLOSED OR USED IN WHOLE OR PART WITHOUT THE EXPRESS WRITTEN PERMISSION OF FOCALTECH SYSTEMS CO.,LTD.**

For the Enhanced MCU, larger program and data memories are supported. Furthermore, a Flash memory is implemented to store programs and some key parameters.

Complex signal processing algorithms are implemented by MCU and DSP accelerator to detect the touches reliably and efficiently. Communication protocol software is also implemented in this MCU to exchange data and control information with the host processor.

- External Interface
  - I2C: an interface for data exchange with host
  - INT: an interrupt signal to inform the host processor that touch data is ready for read
  - RSTN: an external low signal reset the chip. The port is also use to wake up the FT5336GQQ from the Hibernate mode.
- A watch dog timer is implemented to ensure the robustness of the chip.
- A voltage regulator to generate 1.8V for digital circuits from the input VDD3 supply
- Power On Reset (POR) is active until VDDD is higher than some level and hold decades of  $\mu$ s.

## 2.2 MCU

This section describes some critical features and operations supported by the enhanced MCU.

Figure 2-2 shows the overall structure of the MCU block. In addition to the enhanced MCU core, we have added the following circuits,

- A DSP accelerator cooperates with MCU to process the complex algorithms
- Timer: A number of timers are available to generate different clocks
- Clock Manager: To control various clocks under different operation conditions of the system

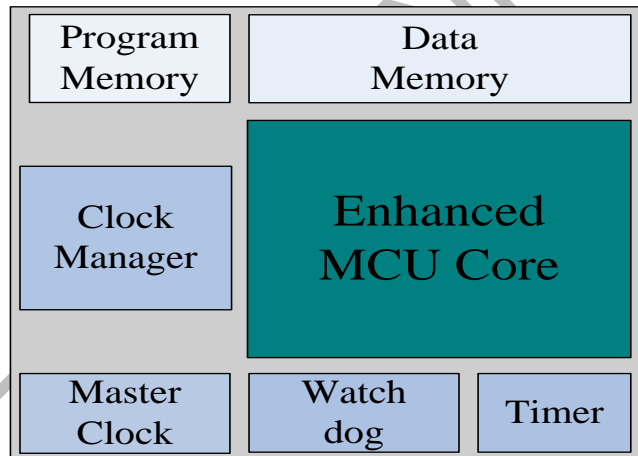

Figure 2-2 MCU Block Diagram

## 2.3 Operation Modes

FT5336GQQ operates in the following three modes:

- Active Mode
 

When in this mode, FT5336GQQ actively scans the panel. The default scan rate is 100 frames per second. The host processor can configure FT5336GQQ to speed up or to slow down.
- Monitor Mode
 

In this mode, FT5336GQQ scans the panel at a reduced speed. The default scan rate is 25 frames per second and the host processor can increase or decrease this rate. In this mode, most algorithms are stopped. A simpler algorithm is being executed to determine if there is a touch or not. When a touch is detected, FT5336GQQ shall enter the Active mode immediately to acquire the touch information quickly. During this mode, the serial port is closed and no data shall be transferred with the host processor.
- Hibernate Mode

In this mode, the chip is set in a power down mode. It shall only respond to the “RESET” signal from the host processor. The chip therefore consumes very little current, which help prolong the standby time for the portable devices.

## 2.4 Host Interface

Figure 2-3 shows the interface between a host processor and FT5336GQQ. This interface consists of the following three sets of signals:

---

HIS DOCUMENT CONTAINS INFORMATION PROPRIETARY TO FOCALTECH SYSTEMS CO.,LTD., AND MAY NOT BE REPRODUCED, DISCLOSED OR USED IN WHOLE OR PART WITHOUT THE EXPRESS WRITTEN PERMISSION OF FOCALTECH SYSTEMS CO.,LTD.

- Serial Interface
- Interrupt from FT5336GQQ to the Host
- Reset Signal from the Host to FT5336GQQ

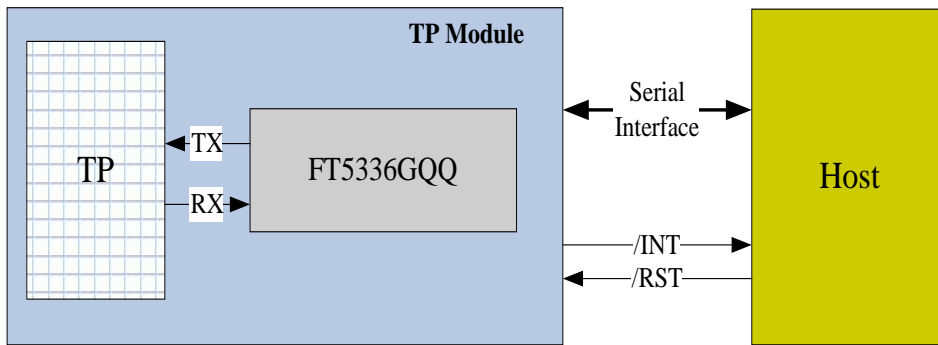

Figure 2-3 Host Interface Diagram

The serial interface of FT5336GQQ is I2C. The detail of the interface is described in detail in Section 2.5. The interrupt signal (/INT) is used for FT5336GQQ to inform the host that data are ready for the host to receive. The /RST signal is used for the host to wake up FT5336GQQ from the Hibernate mode. After resetting, FT5336GQQ shall enter the Active mode.

## 2.5 Serial Interface

FT5336GQQ supports the I2C interfaces, which can be used by a host processor or other devices.

The I2C is always configured in the Slave mode. The data transfer format is shown in Figure 2-4.

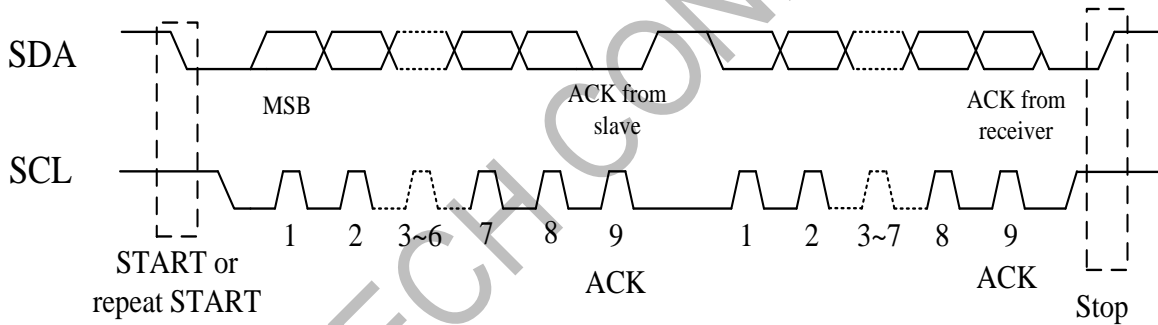

Figure 2-4 I2C Serial Data Transfer Format

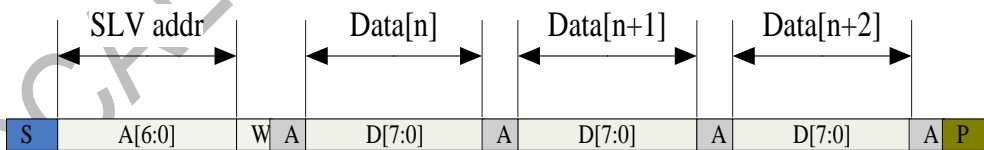

Figure 2-5 I2C master write, slave read

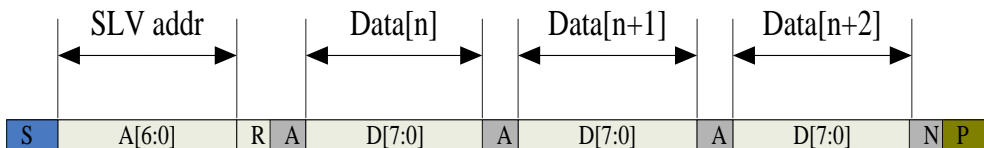

Figure 2-6 I2C master read, slave write

Table 2-1 lists the meanings of the mnemonics used in the above figures.

Table 2-1 Mnemonics Description

HIS DOCUMENT CONTAINS INFORMATION PROPRIETARY TO FOCALTECH SYSTEMS CO.,LTD., AND MAY NOT BE REPRODUCED, DISCLOSED OR USED IN WHOLE OR PART WITHOUT THE EXPRESS WRITTEN PERMISSION OF FOCALTECH SYSTEMS CO.,LTD.

Mnemonics	Description
S	I2C Start or I2C Restart
A[6:0]	Slave address
R/ W	READ/WRITE bit, '1' for read, '0' for write
A(N)	ACK(NACK) bit
P	STOP: the indication of the end of a packet (if this bit is missing, S will indicate the end of the current packet and the beginning of the next packet)

I2C Interface Timing Characteristics is shown in Table 2-2.

**Table 2-2 I2C Timing Characteristics**

Parameter	Min	Max	Unit
SCL frequency	10	400	KHz
Bus free time between a STOP and START condition	4.7	\	us
Hold time (repeated) START condition	4.0	\	us
Data setup time	250	\	ns
Setup time for a repeated START condition	4.7	\	us
Setup Time for STOP condition	4.0	\	us

## 2.6 Proximity Modes

FT5336GQQ support the following three proximity modes:

- Air Swipe

In this mode, FT5336GQQ could recognize the large object movement in two dimensions (x and Y axis). This can enable functions like picture scrolling, page up and page down.

- Glove Usage

FT5336GQQ has increased sensitivity that allows the touch sensors to detect Finger through glove.

- Cheek Check

As soon as user's cheek approaches to mobile phone screen, cheek proximity detection allows the host to turn off the mobile phone screen.

### 3 ELECTRICAL SPECIFICATIONS

#### 3.1 Absolute Maximum Ratings

**Table 3-1 Absolute Maximum Ratings**

Item	Symbol	Value	Unit	Note
Power Supply Voltage 1	VDDA - VSSA	-0.3 ~ +3.6	V	1, 2
Power Supply Voltage 2	VDD3 - VSS	-0.3 ~ +3.6	V	1, 3
I/O Digital Voltage	IOVCC	1.8~3.6	V	1
Operating Temperature	Topr	-40 ~ +85	°C	1
Storage Temperature	Tstg	-55 ~ +150	°C	1

#### Notes

1. If used beyond the absolute maximum ratings, FT5336GQQ may be permanently damaged. It is strongly recommended that the device be used within the electrical characteristics in normal operations. If exposed to the condition not within the electrical characteristics, it may affect the reliability of the device.
2. Make sure VDDA (high)  VSSA (low)
3. Make sure VDD (high)  VSS (low)

#### 3.2 DC Characteristics

**Table 3-2 DC Characteristics (VDDA=VDD3=2.8~3.6V, Ta=-20~70°C)**

Item	Symbol	Unit	Test Condition	Min.	Typ.	Max.	Note
Input high-level voltage	VIH	V		0.7 x IOVCC	--	IOVCC	
Input low -level voltage	VIL	V		-0.3	--	0.3 x IOVCC	
Output high -level voltage	VOH	V	IOH=-0.1mA	0.7 x IOVCC	--	--	
Output low -level voltage	VOL	V	IOH=0.1mA	--	--	0.3 x IOVCC	
I/O leakage current	ILI	uA	Vin=0~VDDA	-1	--	1	
Current consumption (Normal operation mode)	Iopr	mA	VDDA=VDD3 = 2.8V Ta=25°C MCLK=24MHz	--	7.00	--	
Current consumption (Monitor mode)	Imon	mA	VDDA=VDD3 = 2.8V Ta=25°C MCLK=24MHz	--	2.75	--	
Current consumption (Sleep mode)	Islp	uA	VDDA=VDD3 = 2.8V Ta=25°C MCLK=24MHz	--	20	--	
Step-up output voltage	VDD5	V	VDDA=VDD3= 2.8V		0.25		
Power Supply voltage	VDDA VDD3	V		2.8	--	3.6	

Notes: This consumption data is intended for design guidance only. Actual current will depend on the particular sensor design and firmware options.

#### 3.3 AC Characteristics

THIS DOCUMENT CONTAINS INFORMATION PROPRIETARY TO FOCALTECH SYSTEMS CO.,LTD., AND MAY NOT BE REPRODUCED, DISCLOSED OR USED IN WHOLE OR PART WITHOUT THE EXPRESS WRITTEN PERMISSION OF FOCALTECH SYSTEMS CO.,LTD.

**Table 3-3 AC Characteristics of TX & RX**

Item	Symbol	Test Condition	Min	Typ	Max	Unit	Note
TX acceptable clock	ftx		--	150	--	KHz	
TX output rise time	Ttxr		--	140	--	nS	
TX output fall time	Ttxf		--	140	--	nS	
RX input voltage	Trxi		1.2	--	1.6	V	

**3.4 I/O Ports Circuits**

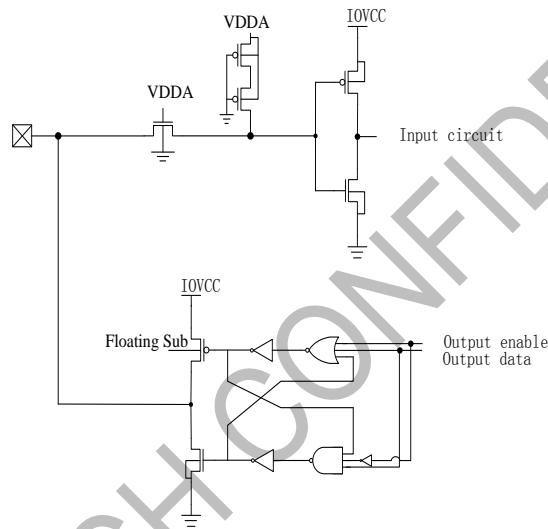

*Figure 3-1 General Purpose In/Out Port Circuit.*

The input/output property can be configured via firmware setting. The firmware can also control its output behavior as push-pull or as open-drain that SDA of I2C interface is required.

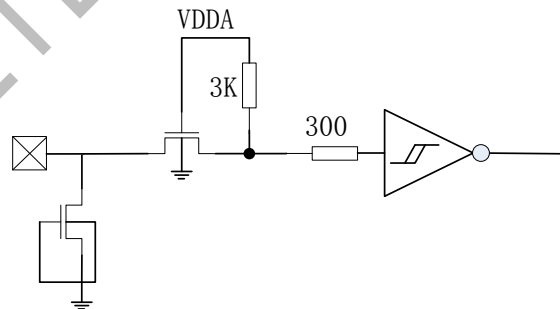

*Figure 3-2 Reset Input Port Circuits*



### 3.5 POWER ON/Reset Sequence

Reset should be pulled down to be low before powering on and powering down. I2C shouldn't be used by other devices during Reset time after VDD powering on ( $T_{rtp}$ ). INT signal will be sent to the host after initializing all parameters and then start to report points to the host. If Power is down, the voltage of supply must be below 0.3V and  $T_{pdt}$  is more than 1ms.

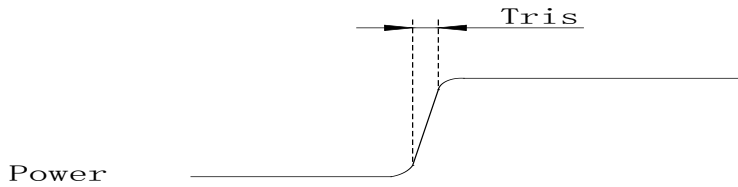

Figure 3-3 Power on time

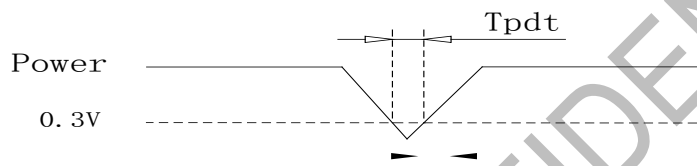

Figure 3-4 Power Cycle requirement

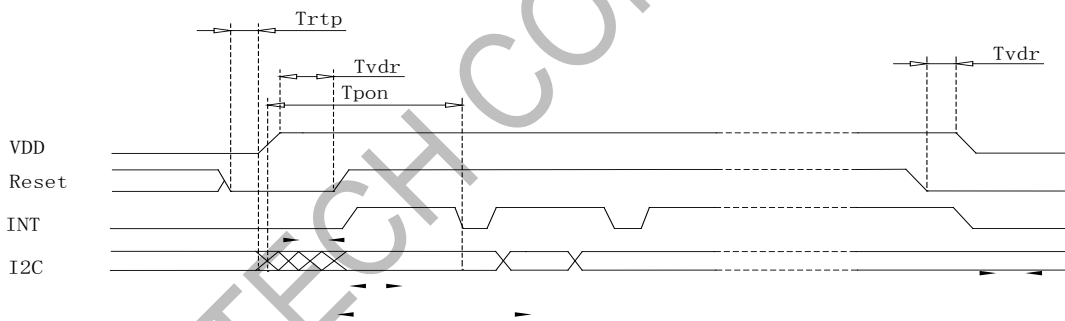

Figure 3-5 Power on Sequence

Reset time must be enough to guarantee reliable reset, the time of starting to report point after resetting approach to the time of starting to report point after powering on.

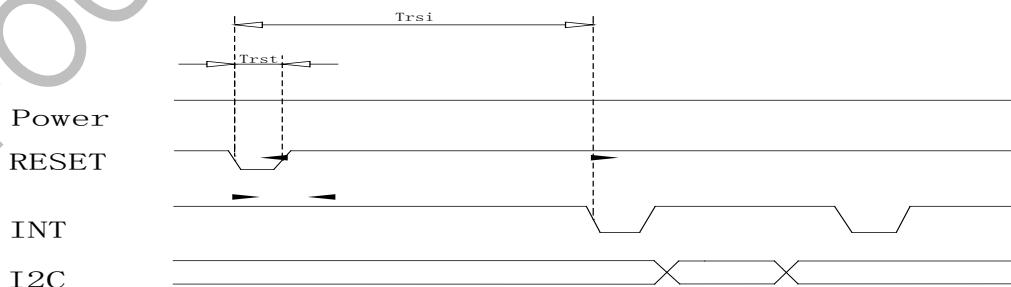

Figure 3-6 Reset Sequence

**Table 3-5 Power on/Reset Sequence Parameters**

Parameter	Description	Min	Max	Units
Tris	Rise time from 0.1VDD to 0.9VDD	--	5	ms
Tpdt	Time of the voltage of supply being below 0.3V	5	--	ms
Trtp	Time of resetting to be low before powering on	100	--	$\mu$ s
Tpon	Time of starting to report point after powering on	200	--	ms
Tvdr	Reset time after VDD powering on	1	--	ms
Trsi	Time of starting to report point after resetting	200	--	ms
Trst	Reset time	1	--	ms

#### 4 PIN CONFIGURATIONS

Pin List of FT5336GQQ

**Table 4-1 Pin Definition of FT5336GQQ**

Name	Pin No.	Type	Description
TX13	36	O	Transmit output pin
TX12	35	O	Transmit output pin
TX11	34	O	Transmit output pin
TX10	33	O	Transmit output pin
TX9	32	O	Transmit output pin
TX8	31	O	Transmit output pin
TX7	30	O	Transmit output pin
TX6	29	O	Transmit output pin
TX5	28	O	Transmit output pin
TX4	27	O	Transmit output pin
TX3	26	O	Transmit output pin
TX2	25	O	Transmit output pin
TX1	24	O	Transmit output pin
VDD5	23	PWR	internal generated 5V power supply, A 1 $\mu$ F ceramic capacitor to ground is required.
VDDA	22	PWR	Analog power supply
VSSA	9	PWR	Analog ground
VSS	37	PWR	Analog ground
VDDD	38	PWR	Digital power supply (1.8V), generated internal. A 1 $\mu$ F ceramic capacitor to ground is required.
VREF	8	PWR	internal generated reference power supply, A 1 $\mu$ F ceramic capacitor to ground is required.
RSTN	39	I	External Reset, Low is active
SCL	43	I/O	I2C clock input
SDA	42	I/O	I2C data input and output
GPIO	41	I/O	General Purpose Input/Output port
INT/ Wakeup	40	I/O	Interrupt request to the host, or Wakeup request from the host.
RX1	44	I	Receiver input pins

HIS DOCUMENT CONTAINS INFORMATION PROPRIETARY TO FOCALTECH SYSTEMS CO.,LTD., AND MAY NOT BE REPRODUCED, DISCLOSED OR USED IN WHOLE OR PART WITHOUT THE EXPRESS WRITTEN PERMISSION OF FOCALTECH SYSTEMS CO.,LTD.

RX2	45	I	Receiver input pins
RX3	46	I	Receiver input pins
RX4	47	I	Receiver input pins
RX5	48	I	Receiver input pins
RX6	1	I	Receiver input pins
RX7	2	I	Receiver input pins
RX8	3	I	Receiver input pins
RX9	4	I	Receiver input pins
RX10	5	I	Receiver input pins
RX11	6	I	Receiver input pins
RX12	7	I	Receiver input pins
RX13	10	I	Receiver input pins
RX14	11	I	Receiver input pins
RX15	12	I	Receiver input pins
RX16	13	I	Receiver input pins
RX17	14	I	Receiver input pins
RX18	15	I	Receiver input pins
RX19	16	I	Receiver input pins
RX20	17	I	Receiver input pins
RX21	18	I	Receiver input pins
RX22	19	I	Receiver input pins
RX23	20	I	Receiver input pins
RX24	21	I	Receiver input pins

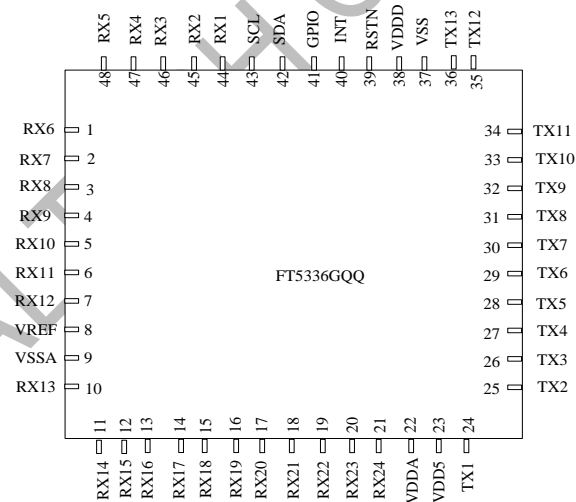

FT5336GQQ Package Diagram

HIS DOCUMENT CONTAINS INFORMATION PROPRIETARY TO FOCALTECH SYSTEMS CO.,LTD., AND MAY NOT BE REPRODUCED, DISCLOSED OR USED IN WHOLE OR PART WITHOUT THE EXPRESS WRITTEN PERMISSION OF FOCALTECH SYSTEMS CO.,LTD.

## 5 PACKAGE INFORMATION

### 5.1 Package Information of QFN-5x5-48L Package

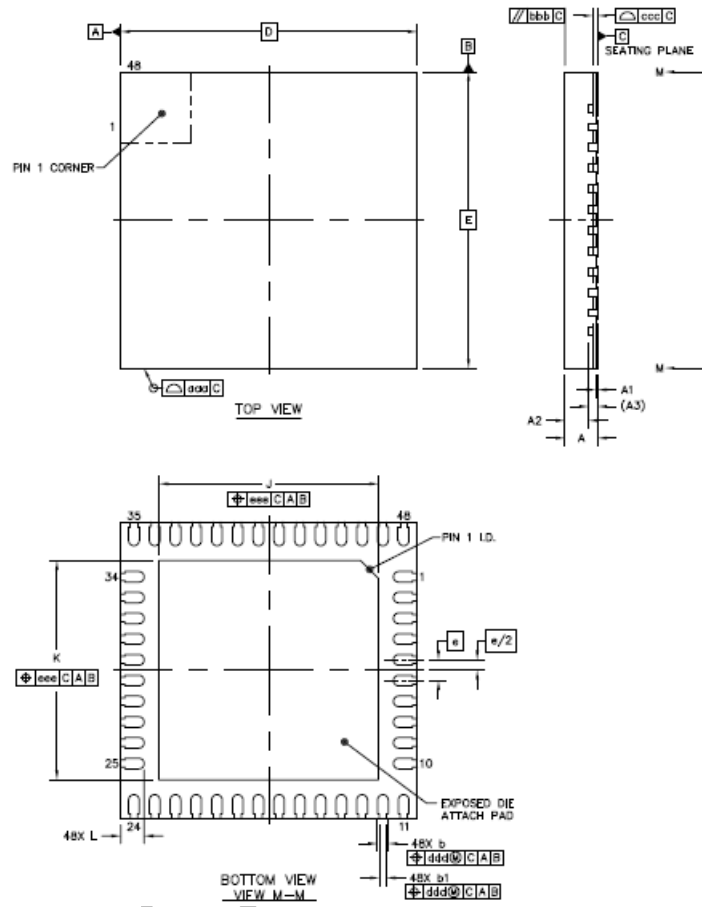

Item	Symbol	Millimeter		
		Min	Type	Max
Total Thickness	A	0.5	0.55	0.6
Stand Off	A1	0	0.035	0.05
Mold Thickness	A2	----	0.4	0.425
L/F Thickness	A3	0.152 REF		
Lead Width	b	0.13	0.18	0.23
Body Size	D	5 BSC		
	E	5 BSC		
Lead Pitch	e	0.35 BSC		
EP Size	J	3.6	3.7	3.8
	K	3.6	3.7	3.8
Lead Length	L	0.35	0.4	0.45
Package Edge Tolerance	aaa	0.1		
Mold Flatness	bbb	0.1		
Co Planarity	ccc	0.08		
Lead Offset	ddd	0.1		
Exposed Pad Offset	eee	0.1		

THIS DOCUMENT CONTAINS INFORMATION PROPRIETARY TO FOCALTECH SYSTEMS CO.,LTD., AND MAY NOT BE REPRODUCED, DISCLOSED OR USED IN WHOLE OR PART WITHOUT THE EXPRESS WRITTEN PERMISSION OF FOCALTECH SYSTEMS CO.,LTD.

**5.2 Order Information**

<b>Package Type</b>	<b>QFN</b>
	<b>48Pin(5 * 5 )</b>
	<b>0.6 - P0.35</b>
<b>Product Name</b>	<b>FT5336</b>

**Note:**

- 1). The last three letters in the product name indicate the package type , lead pitch and thickness and numbers of TX and RX.
- 2). The third last letter indicates the package type .  
**G** : QFN-5\*5
- 3). The second last letter indicates the lead pitch and thickness.  
**M** : 0.6 - P0.35
- 4). The last letter indicates the numbers of TX and RX.  
**J** : 11TX-16RX

**T: Track Code**

**F/R:"F"** for Lead Free process,  
**"R"** for Halogen Free process

**Y: Year Code**

**WW: Week Code**

**S: Lot Code**

**V: IC Version**

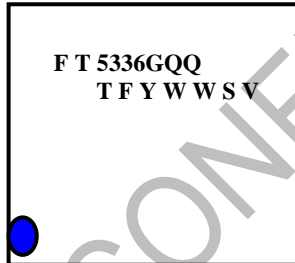

<b>Product Name</b>	<b>Package Type</b>	<b># TX Pins</b>	<b># RX Pins</b>
<b>FT5336GQQ</b>	<b>QFN-48L</b>	<b>13</b>	<b>24</b>

END OF DATASHEET