



**REVISION RECORD**

| REVISION      | REVISION DATE      | PAGE | CONTENTS            |
|---------------|--------------------|------|---------------------|
| <b>VER1.0</b> | <b>2013-012-09</b> |      | <b>FIRST ISSUED</b> |

※ **CONTENTS**

- 1.0 GENERAL SPECIFICATION
- 2.0 BLOCK DIAGRAM
- 3.0 PIN ASSIGNMENT
- 4.0 OPERATING SPECIFICATIONS
- 5.0 OPTICAL CHARACTERISTICS
- 6.0 RELIABILITY TEST
- 7.0 PRECAUTION FOR USING LCM
- 8.0 MECHANICAL DIAGRAM
- 9.0 PACKAGE DRAWING
- 10.0 INSPECTION SPECIFICATION

## 1.0 GENERAL SPECIFICATION

|  |                                     |
|--|-------------------------------------|
| 1. Display Format                                    | 800RGB*600 DOTS                     |
| 2. Power Supply                                      | LCD 3.3V/BACKLIGHT 5.0V             |
| 3. Overall Module Size                               | 228.4mm(W) x 175.4mm(H) x 13.4mm(T) |
| 4. Active Area(W*H)                                  | 211.2mm(W) x 158.4mm(H)             |
| 5. Color Configuration                               | RGB stripe                          |
| 6. Color Depth                                       | 16.7M colors                        |
| 7. Dot Pitch (W*H)                                   | 0.088mm(W) x 0.264mm(H)             |
| 8. Viewing Direction                                 | 6 O'clock                           |
| 9. Display mode                                      | Normally white                      |
| 10. Backlight Options                                | LED-SIDE(White)                     |
| 11. Interface  | LVDS                                |
| 12. Operating temperature                            | -20°C ~ 70°C                        |
| 14. Storage temperature                              | -30°C ~ 80°C                        |
| 13. Power consumption of BL Unit                     | 2.304W(Typ.)                        |
| 14. Power consumption of BL driving circuit(with BL) | 3.072W(Typ.)                        |
| 15. Power consumption of TFT circuit                 | 0.99W(Typ.)                         |
| 16. Weight   | 525g(Typ.)                          |
| 17. ROHS   | ROHS compliant                      |

**Note 1:** Please refer to mechanical drawing.

## 2.0 BLOCK DIAGRAM

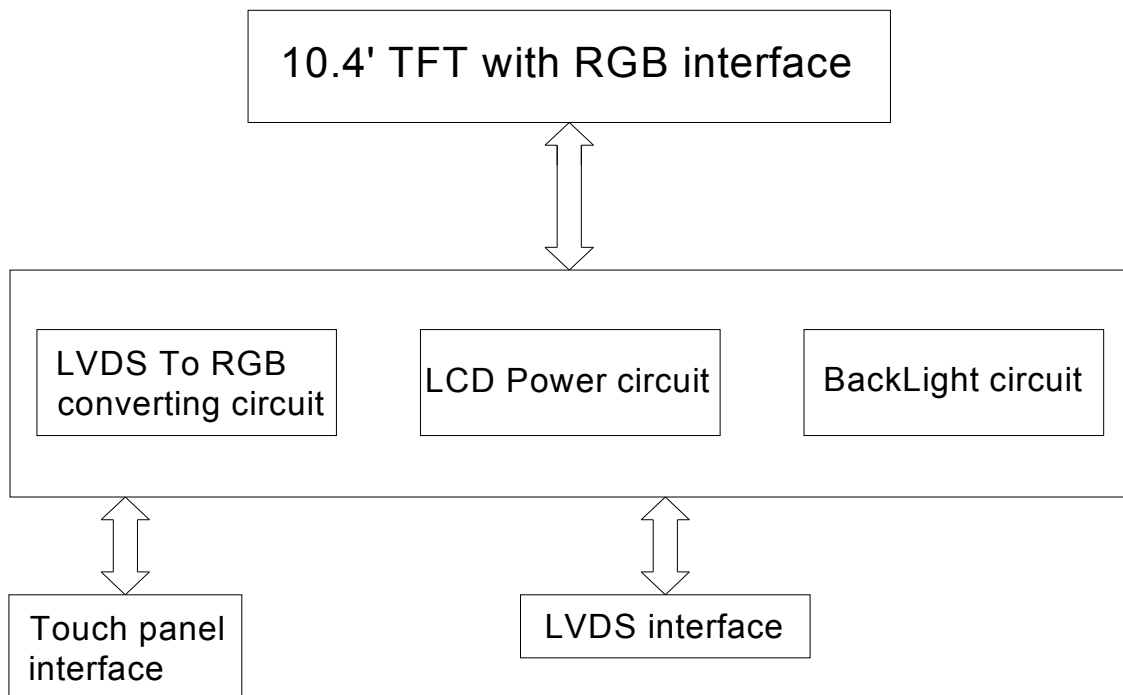

## ATM1040L3A-T1(AZ DISPLAYS) TFT MODULE VER1.0

### 3.0 PIN ASSIGNMENT

Connector on LCM : HIROSE DF19G-20P-1H or compatible, mating with HIROSE DF19-20S-1C or compatible

| Pin No. | Symbol | Function  |
|---------|--------|---|
| 1       | TX0-   | Negative LVDS differential data input(G0,R5-R0)*3                 |
| 2       | TX0+   | Positive LVDS differential data input(G0,R5-R0)*3                 |
| 3       | VSS*1  | Ground  |
| 4       | TX1-   | Negative LVDS differential data input(B1,B0,G5-G1)*3              |
| 5       | TX1+   | Positive LVDS differential data input(B1,B0,G5-G1)*3              |
| 6       | VSS*1  | Ground  |
| 7       | TX2-   | Negative LVDS differential data input(DE, VS,HS,B5-B2)*3          |
| 8       | TX2+   | Positive LVDS differential data input(DE, VS,HS,B5-B2)*3          |
| 9       | VSS*1  | Ground  |
| 10      | CLK-   | Clock Signal(-)   |
| 11      | CLK+   | Clock signal(+)   |
| 12      | VSS*1  | Ground  |
| 13      | TX3-   | Negative LVDS differential data input(B7,B6,G7,G6,R7,R6)*3 *4     |
| 14      | TX3+   | Positive LVDS differential data input(B7,B6,G7,G6,R7,R6)*3 *4     |
| 15      | VDD    | +3.3V power supply for logic and LCM                              |
| 16      | VDD    | +3.3V power supply for logic and LCM                              |
| 17      | BL_DV+ | Backlight driving circuit power in(+5.0V)                         |
| 18      | BL_DV- | Ground of backlight driving circuit, seperated from system ground |
| 19      | PWM    | Backlight On/Off/Dimming control(PWM:100~1000Hz, 0~100%)          |
| 20      | VSS*1  | Ground  |

NOTE 1) PLEASE CONNECT VSS PIN TO GROUND. DON'T USE IT AS NO-CONNECT NOR CONNECTION WITH HIGH IMPEDANCE.

NOTE 2) PLEASE CONNECT NC PIN TO NOTHING. DON'T CONNECT IT TO GROUND NOR TO OTHER SIGNAL INPUT.

NOTE 3) REFER TO NEXT PAGE.

# ATM1040L3A-T1(AZ DISPLAYS) TFT MODULE VER1.0

## RECOMMENDED TRANSMITTER(DS90C386)TO ATM1040L3A INTERFACE ASSIGNMENT

| Device Pin Name    | Signal  | Signal Pattern | Signal Frequency   |
|--------------------|---------|----------------|--------------------|
| TxCLK IN/RxCLK OUT | Dot Clk |                | f                  |
| TxIN0/RxOUT0       | R0      |                | f/16               |
| TxIN1/RxOUT1       | R1      |                | f/8                |
| TxIN2/RxOUT2       | R2      |                | f/4                |
| TxIN3/RxOUT3       | R3      |                | f/2                |
| TxIN4/RxOUT4       | R4      |                | Steady State, Low  |
| TxIN5/RxOUT5       | R7      |                | Steady State, Low  |
| TxIN6/RxOUT6       | R5      |                | Steady State, Low  |
| TxIN7/RxOUT7       | G0      |                | Steady State, Low  |
| TxIN8/RxOUT8       | G1      |                | f/16               |
| TxIN9/RxOUT9       | G2      |                | f/8                |
| TxIN10/RxOUT10     | G6      |                | f/4                |
| TxIN11/RxOUT11     | G7      |                | f/2                |
| TxIN12/RxOUT12     | G3      |                | Steady State, Low  |
| TxIN13/RxOUT13     | G4      |                | Steady State, Low  |
| TxIN14/RxOUT14     | G5      |                | Steady State, Low  |
| TxIN15/RxOUT15     | B0      |                | Steady State, Low  |
| TxIN16/RxOUT16     | B6      |                | f/16               |
| TxIN17/RxOUT17     | B7      |                | f/8                |
| TxIN18/RxOUT18     | B1      |                | f/4                |
| TxIN19/RxOUT19     | B2      |                | f/2                |
| TxIN20/RxOUT20     | B3      |                | Steady State, Low  |
| TxIN21/RxOUT21     | B4      |                | Steady State, Low  |
| TxIN22/RxOUT22     | B5      |                | Steady State, Low  |
| TxIN23/RxOUT23     | RES     |                | Steady State, Low  |
| TxIN24/RxOUT24     | HSYNC   |                | Steady State, High |
| TxIN25/RxOUT25     | VSYNC   |                | Steady State, High |
| TxIN26/RxOUT26     | EN      |                | Steady State, High |
| TxIN27/RxOUT27     | R6      |                | Steady State, High |

Grayscale" Test Pattern (DS90CF386) (Notes I , II ,III)

I . The 16 grayscale test pattern tests device power consumption for a "typical" LCD display pattern. The test pattern approximates signal switching needed to produce groups of 16 vertical stripes across the display.

II . falling edge data strobe (TxCLK IN/RxCLK OUT).

III. Recommended pin to signal mapping. Customer may choose to define differently.

# ATM1040L3A-T1(AZ DISPLAYS) TFT MODULE VER1.0

## Touch Panel Section

Recommended connector: SFW04R-1STAE1LF or compatible(4PINS,Pitch = 1.0mm, bottom side contact)

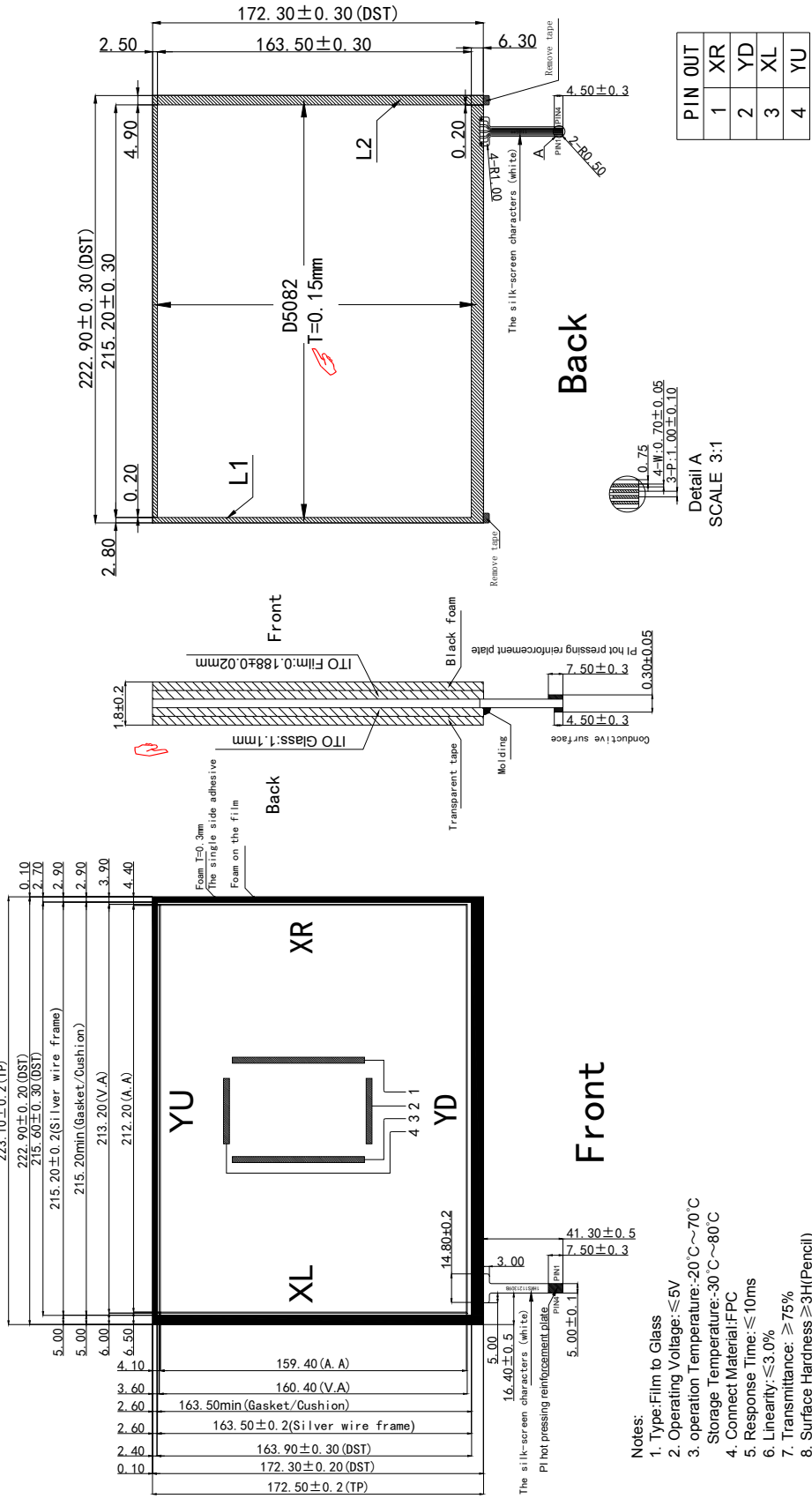

- Notes:
1. Type: Film to Glass
  2. Operating Voltage: ≤ 5V
  3. operation Temperature: -20°C ~ 70°C  
Storage Temperature: -30°C ~ 80°C
  4. Connect Material: FPC
  5. Response Time: ≤ 10ms
  6. Linearity: ≤ 3.0%
  7. Transmittance: ≥ 75%
  8. Surface Hardness ≥ 3H (Pencil)
  9. operation force: ≤ 100g
  10. Resistance:  
(Anti-glare Hard & Mate anti-newton ring coating ITO Film): 300 Ω ~ 850 Ω  
(Stand ard ITO Glass): 150 Ω ~ 550 Ω
  11. Insulating resistance > 10MΩ, 15V(DC)
  12. Unspecified Tolerance: ± 0.30
  13. All materials in the drawing coincide with the ROHS

## 4.0 Operating Specification

### 4.1 ABSOLUTE MAXIMUM RATINGS

| Item                     | Symbol   | Min     | Typ | Max     | Unit |
|--------------------------|----------|---------|-----|---------|------|
| Operating temperature    | Top      | -20     | -   | 70      | °C   |
| Storage temperature      | Tst      | -30     | -   | 80      | °C   |
| Input voltage            | Vin      | Vss-0.3 | -   | Vdd+0.3 | V    |
| Supply voltage for logic | Vdd- Vss | -0.3    | -   | 3.6     | V    |

#### 4.1.1 Typical Operation Conditions

| Item                 | Symbol                   | Condition             | Min                | Typ | Max                | Unit |
|----------------------|--------------------------|-----------------------|--------------------|-----|--------------------|------|
| Power Supply Voltage | V <sub>DD</sub>          | Ta=25°C               | 3.0                | 3.3 | 3.6                | V    |
| Power Supply current | I <sub>DD</sub>          | V <sub>DD</sub> =3.3V | -                  | 300 | -                  | mA   |
| BL circuit voltage   | V <sub>LED</sub> (PIN17) | Ta=25°C               | 4.8                | 5.0 | 5.2                | V    |
| BL circuit current   | I <sub>LED</sub>         | V <sub>LED</sub> =5V  |                    | 614 |                    | mA   |
| Input voltage (high) | V <sub>ih</sub>          | H level               | 0.7V <sub>dd</sub> | -   | V <sub>dd</sub>    | V    |
| Input voltage (low)  | V <sub>il</sub>          | L level               | V <sub>ss</sub>    | -   | 0.3V <sub>dd</sub> | V    |

#### 4.1.2 Backlight driving conditions

| Item                                   | Symbol          | Condition              | Min   | Typ | Max  | Unit | Remark |
|--|-----------------|------------------------|-------|-----|------|------|--------|
| Backlight Voltage<br>(To LED directly) | V <sub>BL</sub> | I <sub>BL</sub> =240mA | -     | 9.6 | 10.5 | V    | Note1  |
| LED life time                          | --              | --                     | 10000 | --  | --   | H    | Note2  |

**Note 1:** The LED Supply Voltage is defined by the number of LED at Ta=25°C and I<sub>BL</sub> =240mA.

**Note 2:** The "LED life time" is defined as the module brightness decrease to 50% original brightness at Ta=25°C and I<sub>BL</sub> =240mA.



## 4.2 TIMING CHARACTERISTICS

### 4.2.1 Data Input Format

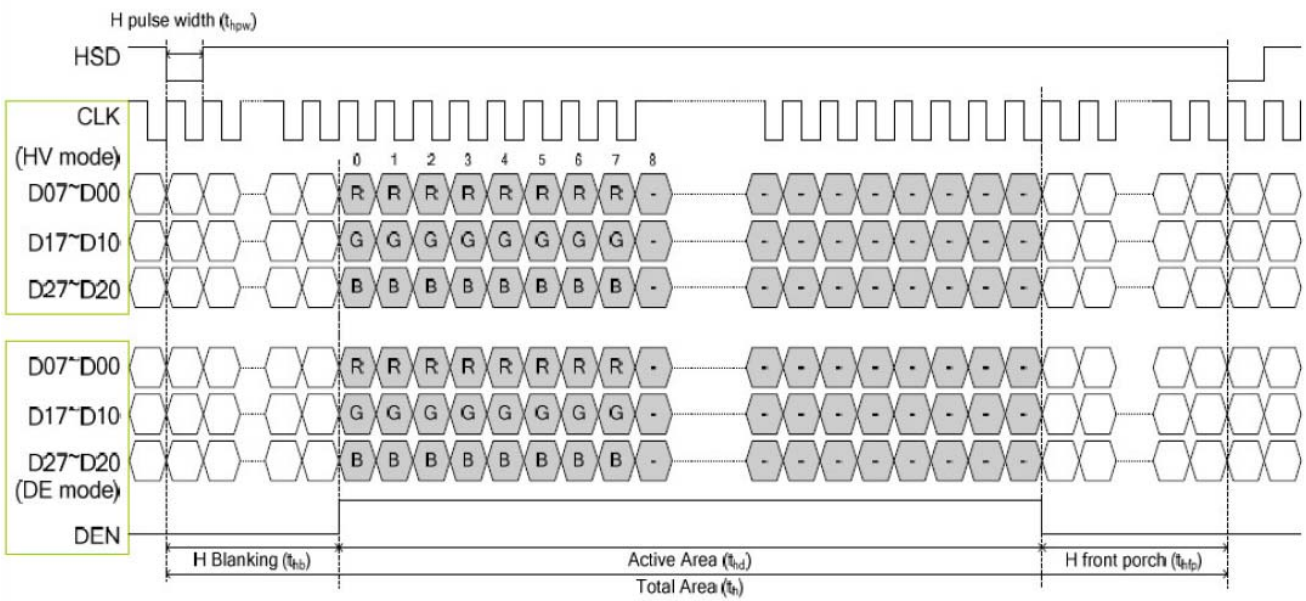
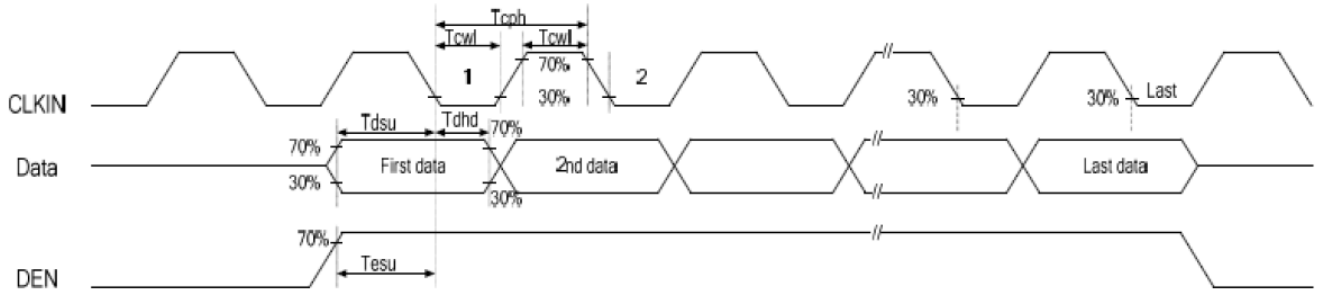

4.2.2 AC Electrical Characteristics

| Item                   | Symbol     | Values |      |      | Unit | Remark |
|------------------------|------------|--------|------|------|------|--------|
|                        |            | Min.   | Typ. | Max. |      |        |
| HS setup time          | $T_{hst}$  | 8      | -    | -    | Ns   |        |
| HS hold time           | $T_{hhd}$  | 8      | -    | -    | Ns   |        |
| VS setup time          | $T_{vst}$  | 8      | -    | -    | Ns   |        |
| VS hold time           | $T_{vhd}$  | 8      | -    | -    | Ns   |        |
| Data setup time        | $T_{dsu}$  | 8      | -    | -    | Ns   |        |
| Data hole time         | $T_{dhhd}$ | 8      | -    | -    | Ns   |        |
| DE setup time          | $T_{esu}$  | 8      | -    | -    | Ns   |        |
| DE hole time           | $T_{ehd}$  | 8      | -    | -    | Ns   |        |
| VDD Power On Slew rate | $T_{POR}$  | -      | -    | 20   | ms   |        |
| RSTB pulse width       | $T_{Rst}$  | 10     | -    | -    | us   |        |
| CLKIN cycle time       | $T_{coh}$  | 20     | -    | -    | Ns   |        |
| CLKIN pulse duty       | $T_{cwh}$  | 40     | 50   | 60   | %    |        |
| Output stable time     | $T_{sst}$  | -      | -    | 6    | us   |        |

4.2.3 Timing

| Item                    | Symbol | Values |      |      | Unit | Remark |
|-------------------------|--------|--------|------|------|------|--------|
|                         |        | Min.   | Typ. | Max. |      |        |
| Horizontal Display Area | thd    | -      | 800  | -    | DCLK |        |
| DCLK Frequency          | fclk   | -      | 40   | 50   | MHz  |        |
| One Horizontal Line     | th     | 862    | 1056 | 1200 | DCLK |        |
| HS pulse width          | thpw   | 1      | -    | 40   | DCLK |        |
| HS Back Porch(Blanking) | thb    | 46     | 46   | 46   | DCLK |        |
| HS Front Porch          | thfp   | 16     | 210  | 354  | DCLK |        |

| Item                    | Symbol | Values |      |      | Unit | Remark |
|-------------------------|--------|--------|------|------|------|--------|
|                         |        | Min.   | Typ. | Max. |      |        |
| Vertical Display Area   | tvd    | -      | 600  | -    | TH   |        |
| VS period time          | tv     | 624    | 635  | 700  | TH   |        |
| VS pulse width          | tvpw   | 1      | -    | 20   | TH   |        |
| VS Back Porch(Blanking) | tvb    | 23     | 23   | 23   | TH   |        |
| VS Front Porch          | tvfp   | 1      | 12   | 77   | TH   |        |

**5.0 OPTICAL CHARACTERISTICS**

| Item                | Symbol | Condition              | Min | Typ | Max | Unit  | Remarks  | Note |
|---------------------|--------|------------------------|-----|-----|-----|-------|----------|------|
| Reponse time        | Tr     | Ta = 25°C              | --- | 10  | 20  | ms    | ---      | 3    |
|                     | Tf     |                        | --- | 15  | 30  | ms    | ---      | 3    |
| Luminance           | L      | I <sub>BL</sub> =240mA | 160 | 200 | --  | cd/m2 | ---      | --   |
| Contrast            |        | Ta = 25°C              | 300 | 500 | --- | ---   | ---      | 4    |
| Viewing angle range | θ      | Cr ≥ 10                | 40  | 50  | --- | deg   | ∅ = 90°  | 1    |
|                     |        |                        | 50  | 60  | --- | deg   | ∅ = 270° | 1    |
|                     |        |                        | 60  | 70  | --- | deg   | ∅ = 0°   | 1    |
|                     |        |                        | 60  | 70  | --- | deg   | ∅ = 180° | 1    |

**Test Conditions:**

- I<sub>BL</sub>=240mA (Backlight current), the ambient temperature is 25°C.
- The test systems refer to Note 2.

**Note 1:** Definition of viewing angle range

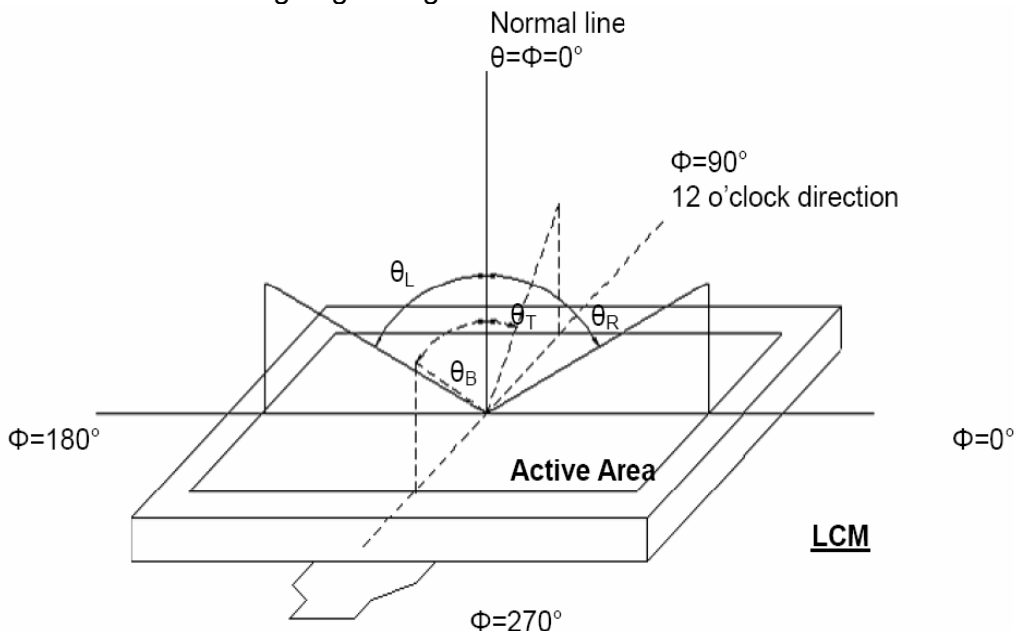

Figure 5.1 Definition of viewing angle.

**Note 2:** Definition of optical measurement system.

The optical characteristics should be measured in dark room. After 30 minutes operation, the optical properties are measured at the center point of the LCD screen. (Response time is measured by Photo detector TOPCON)

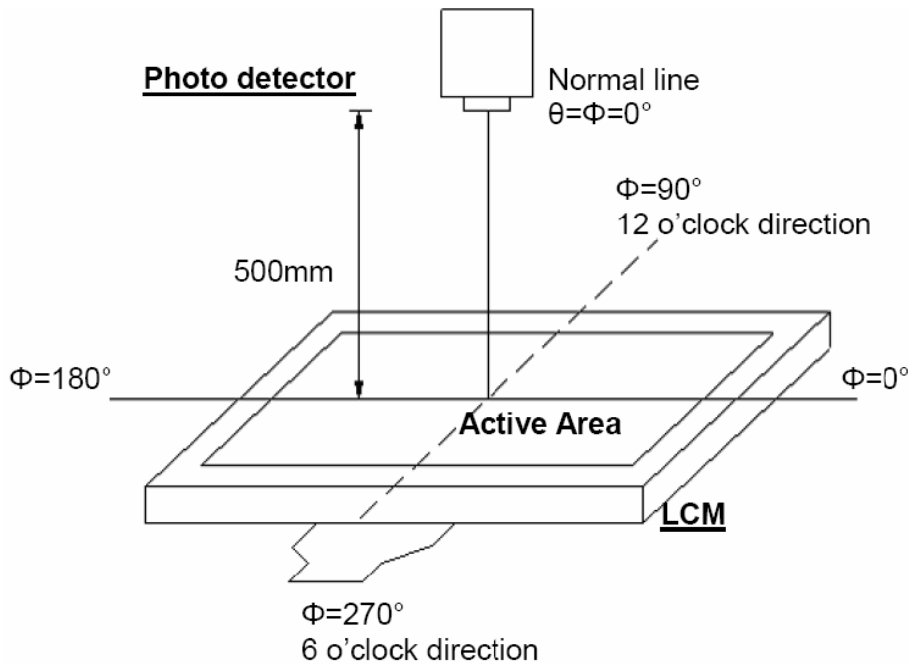

Figure 5.2 Optical measurement system setup

**Note 3:** Definition of Response time

The response time is defined as the LCD optical switching time interval between "White" state and "Black" state. Rise time (TON) is the time between photo detector output intensity changed from 90% to 10%. And fall time (TOFF) is the time between photo detector output intensity changed from 10% to 90%.

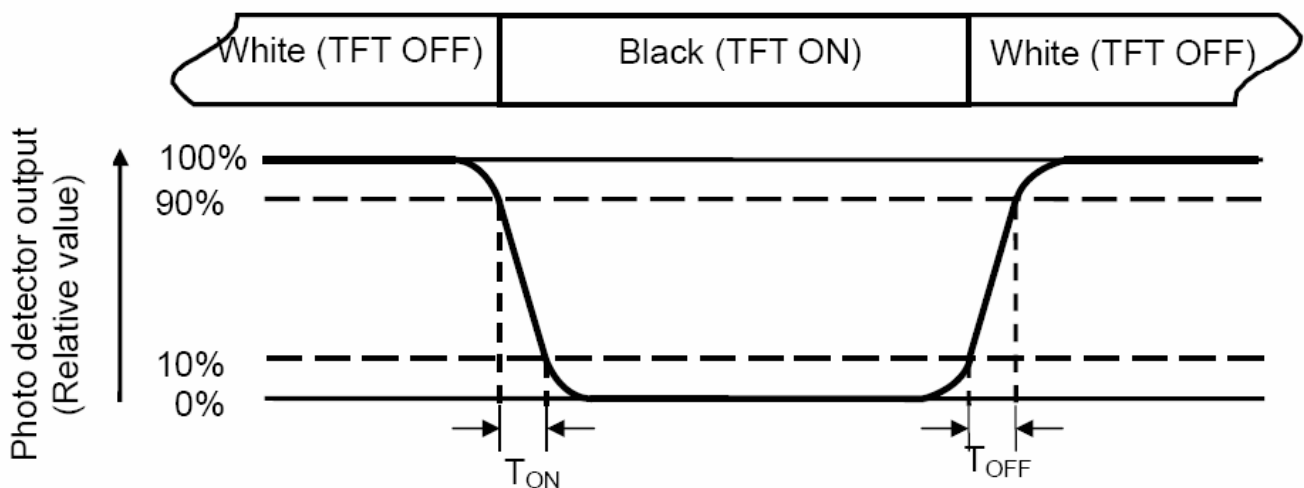
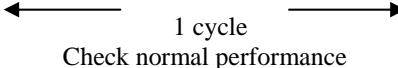

Figure 5.3 Definition of response.

**Note 4:** Definition of contrast ratio

$$\text{Contrast ratio(CR)} = \frac{\text{Luminance measured when LCD on the "white" state}}{\text{Luminance measured when LCD on the "black" state}}$$

## 6.0 RELIABILITY TEST

| NO | Test Item          | Description                            | Test Condition  | Remark  |                |
|----|--------------------|--|---|---|----------------|
| 1  | Environmental Test | High temperature storage               | Applying the high storage temperature Under normal humidity for a long time Check normal performance  | 80 °C<br>96hrs  |                |
| 2  |                    | Low temperature storage                | Applying the low storage temperature Under normal humidity for a long time Check normal performance   | -30°C<br>96hrs  |                |
| 3  |                    | High temperature Operation             | Apply the electric stress(Volatge and current) Under high temperature for a long time   | 70 °C<br>96hrs  | Note1          |
| 4  |                    | Low temperature Operation              | Apply the electric stress Under low temperature for a long time   | -20°C<br>96hrs  | Note1<br>Note2 |
| 5  |                    | High temperature/High Humidity Storage | Apply high temperature and high humidity storage for a long time  | 90% RH<br>40°C<br>96hrs   | Note2          |
| 6  |                    | Temperature Cycle                      | Apply the low and high temperature cycle<br>-30°C <> 25°C <> 80°C <> 25°C<br>30min 10min 30min 10min<br><br>1 cycle<br>Check normal performance | -30°C/80°C<br>10 cycle  |                |
| 7  | Mechanical Test    | Vibration test(Package state)          | Applying vibration to product check normal performance  | Freq:10-55Hz<br>Max<br>Acceleration 5G<br>1cycle time:1min<br>time<br>X.Y.Z direction<br>for 15 mines |                |
| 8  |                    | Shock test(package state)              | Applying shock to product check normal performance  | Drop them through 70cm height to strike horizontal plane  |                |
| 9  | Other              |  |   |   |                |

### Remark

Note1:Normal operations condition (25°C±5°C).

Note2:Pay attention to keep dewdrops from the module during this test.

## 7.0 PRECAUTION FOR USING LCM

1. When design the product with this LCD Module, make sure the viewing angle matches to its purpose of usage.
2. As LCD panel is made of glass substrate, Dropping the LCD module or banging it against hard objects may cause cracking or fragmentation. Especially at corners and edges.
3. Although the polarizer of this LCD Module has the anti-glare coating, always be careful not to scratch its surface. Use of a plastic cover is recommended to protect the surface of polarizer.
4. If the LCD module is stored at below specified temperature, the LC material may freeze and be deteriorated. If it is stored at above specified temperature, the molecular orientation of the LC material may change to Liquid state and it may not revert to its original state. Excessive temperature and humidity could cause polarizer peel off or bubble. Therefore, the LCD module should always be stored within specified temperature range.
5. Saliva or water droplets must be wiped off immediately as those may leave stains or cause color changes if remained for a long time. Water vapor will cause corrosion of ITO electrodes.
6. If the surface of LCD panel needs to be cleaned, wipe it swiftly with cotton or other soft cloth. If it is not still clean enough, blow a breath on the surface and wipe again.
7. The module should be driven according to the specified ratings to avoid malfunction and permanent damage.  
Applying DC voltage cause a rapid deterioration of LC material. Make sure to apply alternating waveform by continuous application of the M signal. Especially the power ON/OFF sequence should be kept to avoid latchup of driver LSIs and DC charge up to LCD panel.

### 8. Mechanical Considerations

- a) LCM are assembled and adjusted with a high degree of precision. Avoid excessive shocks and do not make any alterations or modifications. The following should be noted.
- b) Do not tamper in any way with the tabs on the metal frame.
- c) Do not modify the PCB by drilling extra holes, changing its outline, moving its components or modifying its pattern.
- d) Do not touch the elastomer connector; especially insert a backlight panel (for example, EL).
- e) When mounting a LCM makes sure that the PCB is not under any stress such as bending or twisting.  
Elastomer contacts are very delicate and missing pixels could result from slight dislocation of any of the elements.
- f) Avoid pressing on the metal bezel, otherwise the elastomer connector could be deformed and lose contact, resulting in missing pixels.

### 9. Static Electricity

#### a) Operator

**Wear the electrostatics shielded clothes because human body may be statically charged if not wear shielded clothes.**

**Never touch any of the conductive parts such as the LSI pads; the copper leads on the PCB and the interface**

#### **terminals**

**with any parts of the human body.**

#### b) Equipment

There is a possibility that the static electricity is charged to the equipment, which has a function of peeling or friction

action (ex: conveyer, soldering iron, working table). Earth the equipment through proper resistance

(electrostatic

earth:  $1 \times 10^8$  ohm).

Only properly grounded soldering irons should be used.

If an electric screwdriver is used, it should be well grounded and shielded from commutator sparks.

The normal static prevention measures should be observed for work clothes and working benches; for the latter

conductive (rubber) mat is recommended.

c) Floor

**Floor is the important part to drain static electricity, which is generated by operators or equipment.**

There is a possibility that charged static electricity is not properly drained in case of insulating floor. Set the electrostatic earth (electrostatic earth:  $1 \times 10^8$  ohm).

d) Humidity

Proper humidity helps in reducing the chance of generating electrostatic charges. Humidity should be kept over

50%RH.

e) Transportation/storage

**The storage materials also need to be anti-static treated because there is a possibility that the human body or storage**

**materials such as containers may be statically charged by friction or peeling.**

The modules should be kept in antistatic bags or other containers resistant to static for storage.

f) Soldering

Solder only to the I/O terminals. Use only soldering irons with proper grounding and no leakage.

Soldering temperature :  $280^{\circ} \text{C} \pm 10^{\circ} \text{C}$

Soldering time: 3 to 4 sec.

Use eutectic solder with resin flux fill.

If flux is used, the LCD surface should be covered to avoid flux spatters. Flux residue should be removed afterwards.

g) Others

**The laminator (protective film) is attached on the surface of LCD panel to prevent it from scratches or stains. It should**

**be peeled off slowly using static eliminator.**

Static eliminator should also be installed to the workbench to prevent LCD module from static charge.

10. Operation

a) Driving voltage should be kept within specified range; excess voltage shortens display life.

b) Response time increases with decrease in temperature.

c) Display may turn black or dark blue at temperatures above its operational range; this is (however not pressing on the viewing area) may cause the segments to appear "fractured".

d) Mechanical disturbance during operation (such as pressing on the viewing area) may cause the segments to appear "fractured".

11. If any fluid leaks out of a damaged glass cell, wash off any human part that comes into contact with soap and



water. The toxicity is extremely low but caution should be exercised at all the time.

12. Disassembling the LCD module can cause permanent damage and it should be strictly avoided.
13. LCD retains the display pattern when it is applied for long time (Image retention). To prevent image retention, do not apply the fixed pattern for a long time. Image retention is not a deterioration of LCD. It will be removed after display pattern is changed.
14. Do not use any materials, which emit gas from epoxy resin (hardener for amine) and silicone adhesive agent (dealcohol or deoxym) to prevent discoloration of polarizer due to gas.
15. Avoid the exposure of the module to the direct sunlight or strong ultraviolet light for a long time.

8.0 MECHANICAL DIAGRAM

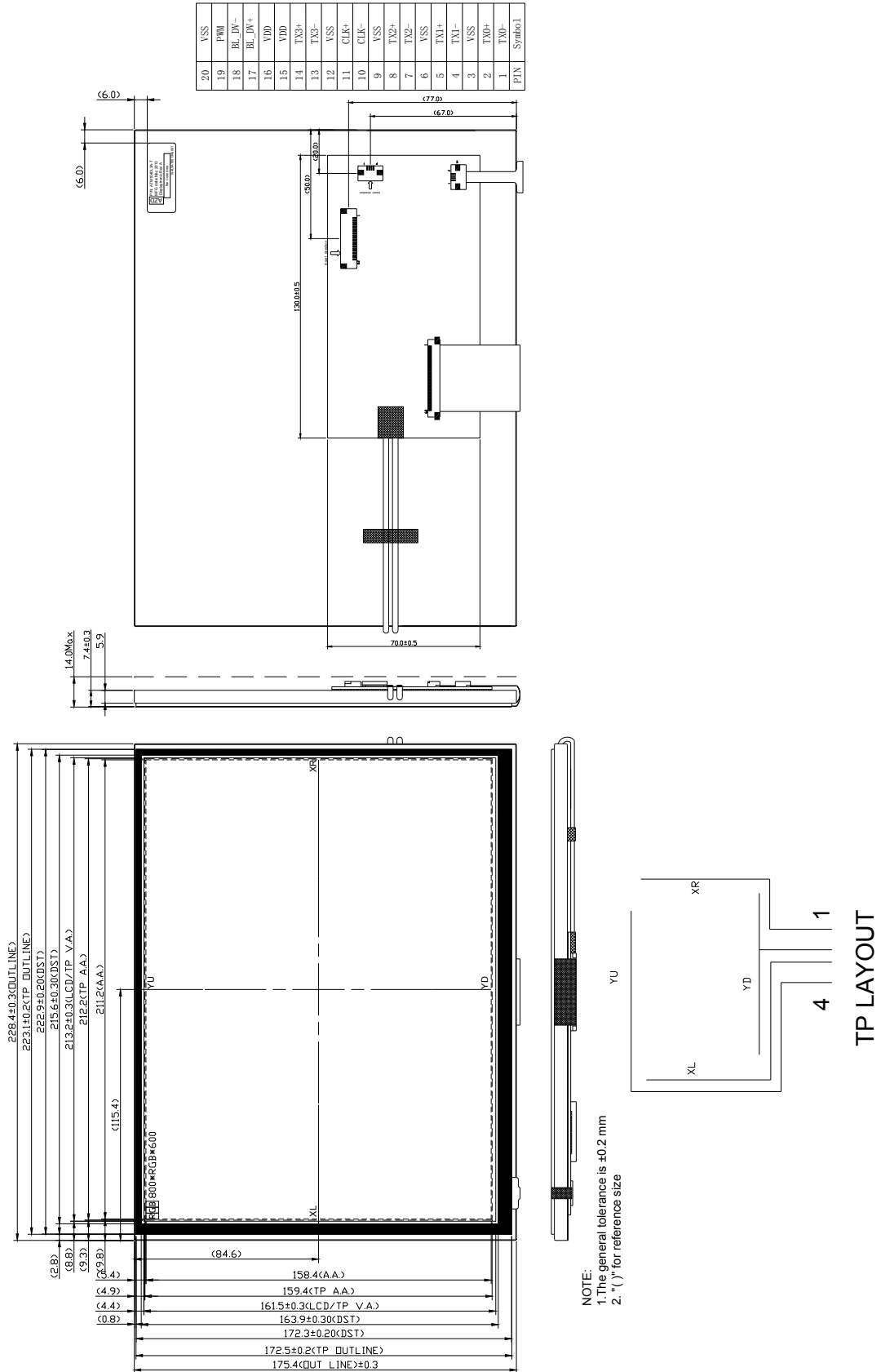

## 9.0 PACKAGE DRAWING

TBD.

## 10.0 INSPECTION SPECIFICATION

### SCOPE SPECIFICATIONS CONTAIN

- 1.1 DISPLAY QUALITY EVALUATION
- 1.2 MECHANICS SPECIFICATION

### SAMPLING PLAN

UNLESS THERE IS OTHER AGREEMENT, THE SAMPLING PLAN FOR INCOMING INSPECTION SHALL FOLLOW MIL-STD-105E.

- 2.1 LOT SIZE: QUANTITY PER SHIPMENT AS ONE LOT (DIFFERENT MODEL AS DIFFERENT LOT ).
- 2.2 SAMPLING TYPE: NORMAL INSPECTION, SINGLE SAMPLING.
- 2.3 SAMPLING LEVEL: LEVEL II.
- 2.4 AQL: ACCEPTABLE QUALITY LEVEL  
 MAJOR DEFECT: AQL=0.65  
 MINOR DEFECT: AQL=1.0

### PANEL INSPECTION CONDITION

- 3.1 ENVIRONMENT:  
 ROOM TEMPERATURE: 25±5°C.  
 HUMIDITY: 65±5% RH.  
 ILLUMINATION: 300 ~ 700 LUX.
- 3.2 INSPECTION DISTANCE:  
 35±5 CM
- 3.3 INSPECTION ANGLE:  
 THE VISION OF INSPECTOR SHOULD BE PERPENDICULAR TO THE SURFACE OF THE MODULE.
- 3.4 INSPECTION TIME:  
 PERCEPTIBILITY TEST TIME: 20 SECONDS MAX.

### 4. DISPLAY QUALITY



- 4.1 FUNCTION RELATED:  
 THE FUNCTION DEFECTS OF LINE DEFECT, ABNORMAL DISPLAY, AND NO DISPLAY ARE CONSIDERED MAJOR DEFECTS.
- 4.2 BRIGHT/DARK DOTS:

| Defect Type                | Specification | Major | Minor |
|----------------------------|---------------|-------|-------|
| Bright Dots                | $N \leq 3$    |       | ●     |
| Dark Dots                  | $N \leq 4$    |       | ●     |
| Total Bright and Dark Dots | $N \leq 6$    |       | ●     |

Note: 1:

- The definition of dot: The size of a defective dot over 1/2 of whole dot is regarded as one defective dot.
- Bright dot: Dots appear bright and unchanged in size in which LCD panel is displaying under black pattern.
- The bright dot defect must be visible through 2% ND filter
- Dark dot: Dots appear dark and unchanged in size in which LCD panel is displaying under pure red, green, blue pattern.

#### 4.3 Pixel Definition:

|   |   |   |   |   |   |   |   |   |  |   |                     |
|---|---|---|---|---|---|---|---|---|--|---|---------------------|
| R | G | B | R | G | B | R | G | B |  |  | Dot Defect          |
| R | G | B | R | G | B | R | G | B |  |  | Adjacent Dot Defect |
| R | G | B | R | G | B | R | G | B |  |  | Cluster             |

Note 1:

If pixel or partial sub-pixel defects exceed 50% of the affected pixel or sub-pixel area, it shall be considered as 1 defect.

Note 2:

There should be no distinct non-uniformity visible through 2% ND Filter within 2 sec inspection times.

ATM1040L3A-T1(AZ DISPLAYS) TFT MODULE VER1.0

4.4 Visual Inspection specifications:

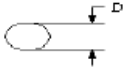
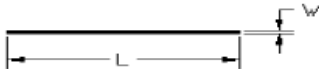
| <u>Defect Type</u>   |                   | <u>Specification Size</u>  | <u>Count(N)</u> | Major                         | Minor |   |
|--|-------------------|--|-----------------|-------------------------------|-------|---|
| Dot Shape<br>(Particle · Scratch and Bubbles in display area)<br>           |                   | $D \leq 0.3 \text{ mm}$  | Ignored         |                               |       |   |
|  |                   | $0.3\text{mm} < D \leq 0.5\text{mm}$                             | $N \leq 4$      |                               | •     |   |
|  |                   | $D > 0.5\text{mm}$   | $N=0$           |                               |       |   |
| Newton Ring (Only for Touch panel)   |                   | $D \leq 70\text{mm}$   | $N \leq 4$      |                               | •     |   |
|  |                   | $D > 70\text{mm}$  | $N=0$           |                               |       |   |
| TSP Fish Eyes (Only for Touch panel)<br>(Bubble/Dent)  |                   | $0.1\text{mm} < D \leq 0.2\text{mm}$                             | $N \leq 4$      |                               |       |   |
|  |                   | $0.2\text{mm} < D \leq 0.3\text{mm}$                             | $N \leq 3$      |                               | •     |   |
|  |                   | $0.3 < D \leq 0.4$   | $N \leq 2$      |                               |       |   |
| Line Shape<br>(Particles · Scratch · Lint and Bubbles in display area)<br> |                   | $W \leq 0.07 \text{ mm}$   | Ignored         |                               |       |   |
|  |                   | $0.07\text{mm} < W \leq 0.1\text{mm}$<br>and $L \leq 5\text{mm}$ | $N \leq 4$      |                               | •     |   |
|  |                   | $W > 0.10\text{mm}$ or $L > 5\text{mm}$                          | $N=0$           |                               |       |   |
| Bubble in cell (active area)   |                   | It should be found by eyes                                       |                 |                               | •     |   |
| Bezel  | Scratch           | No harm  |                 |                               | •     |   |
|  | Dirt              |  |                 |                               | •     |   |
|  | Wrap              |  |                 |                               | •     |   |
|  | Sunken            |  |                 |                               | •     |   |
| Label  | No label          | No   |                 |                               | •     |   |
|  | Inverted label    |  |                 |                               | •     |   |
|  | Broken            |  |                 |                               | •     |   |
|  | Dirt              |  |                 | Word can be read.             |       | • |
|  | Not clear         |  |                 |                               | •     |   |
|  | Word out of shape |  |                 |                               | •     |   |
|  | Mistake           |  |                 |                               | •     |   |
|  | Position          |  |                 | Be attached on right position |       | • |
| Screw  | Not enough        | No   |                 |                               | •     |   |
|  | Limp              | No   |                 |                               | •     |   |

## ATM1040L3A-T1(AZ DISPLAYS) TFT MODULE VER1.0

---

|           |                   |                            |  |   |
|-----------|-------------------|----------------------------|--|---|
| Connector | Connection status | No bend on pins and damage |  | • |
| FPC/FFC   | Broken            | No                         |  | • |

Note: Extraneous substance and scratch not affecting the display of image, for instance, extraneous substance under polarizer film but outside the display area, or scratch on metal bezel and backlight module or polarizer film outside the display area, shall not be considered as defective or non-conforming.