

AZ DISPLAYS

SPECIFICATIONS FOR LIQUID CRYSTAL DISPLAY

CUSTOMER APPROVAL			
※ PART NO. : <u>ATM0784L2 (AZ DISPLAYS) VER1.0</u>			
APPROVAL		COMPANY CHOP	
CUSTOMER COMMENTS			

AZ DISPLAYS ENGINEERING APPROVAL		
DESIGNED BY	CHECKED BY	APPROVED BY
XW		

REVISION RECORD

REVISION	REVISION DATE	PAGE	CONTENTS
PRELIMINARY VER1.0	2020-09-02 2020-09-18	3,5,6,9 ,12	PRELIMINARY UPDATE MIPI CHANNEL INFORMATION \ MODULE BRIGHTNESS \ TEMPERATURE RANGE

※ **CONTENTS**

1. GENERAL SPECIFICATIONS
2. OUTLINE DRAWING
3. INTERFACE SIGNALS
4. ABSOLUTE MAXIMUM RATINGS
5. ELECTRICAL SPECIFICATIONS AND INPUT TIMING TABLE
6. OPTICAL CHARACTERISTICS
7. RELIABILITY TEST ITEMS AND CRITERIA
8. PACKAGE DRAWING
9. PRESCATION FOR USING LCM
10. INSPECTION SPECIFICATION

1. GENERAL SPECIFICATIONS

ATM0784L2 is a TFT-LCD module. It is composed of a TFT-LCD panel, driver IC, FPC, a back light unit. The 7.84" display area contains 400(RGB) x 1280 pixels and can display up to 16.7M colors. This product accords with RoHS environmental criterion.

Item	Specification	Remark
1. LCD size	7.84 inch(Diagonal)	
2. Driver element	a-Si TFT active matrix	
3. Resolution	400x(RGB)x1280 (Portrait mode)	
4. Display mode	Normally black, Transmissive, IPS	
5. Dot Pitch (W*H)	0.0495mm(W)x0.1485mm(H)	
6. Pixel pitch(W*H)	0.1485mm(W) x 0.1485mm(H)	
7. Active Area(W*H)	190.08mm(W) x 59.4mm(H)	
8. Module size (W*H)	205.78mm(W)x67.8mm(H)x 4.75mm(D)	Note 1
9. Surface treatment	Anti-glare	
10. Color arrangement	RGB-stripe	
11. Color	16.7M	
12. Viewing angle(L/R/T/B)	80/80/80/80	
13. Interface	1/2/3/4 lane MIPI	
14. LCD controller	ST7703	
15. LCM Brightness	500 cd/m ² (Typ.)	
16. Backlight driving condition	120mA @18V (Typ.)	
17. Touch panel	/	
18. Touch controller	/	
19. Operation Temperature	-20~70 °C	
20. Weight	T.B.D	
21. RoHS	RoHS compliant	

Note 1: Please refer to mechanical drawing.

ATM0784L2(AZ DISPLAYS)TFT MODULE VER1.0

2. OUTLINE DRAWING

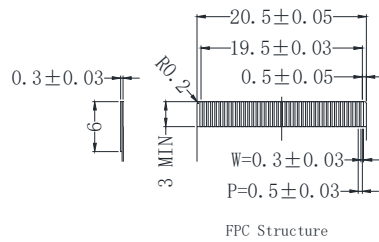
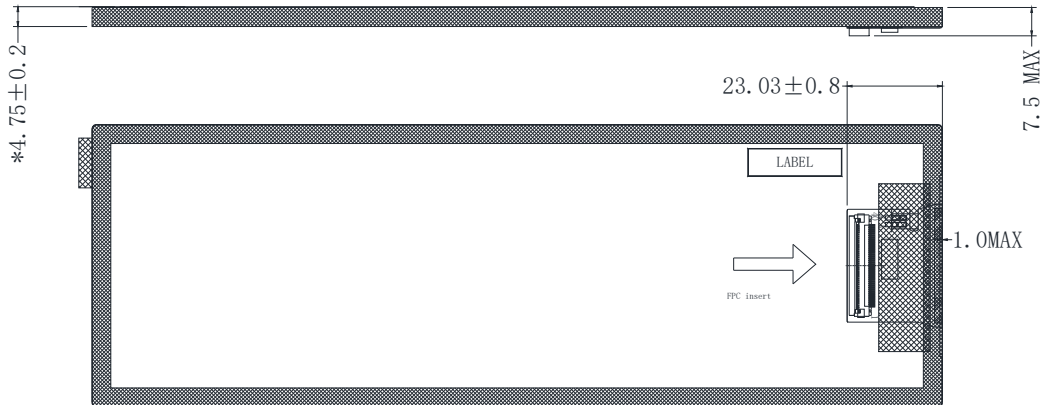
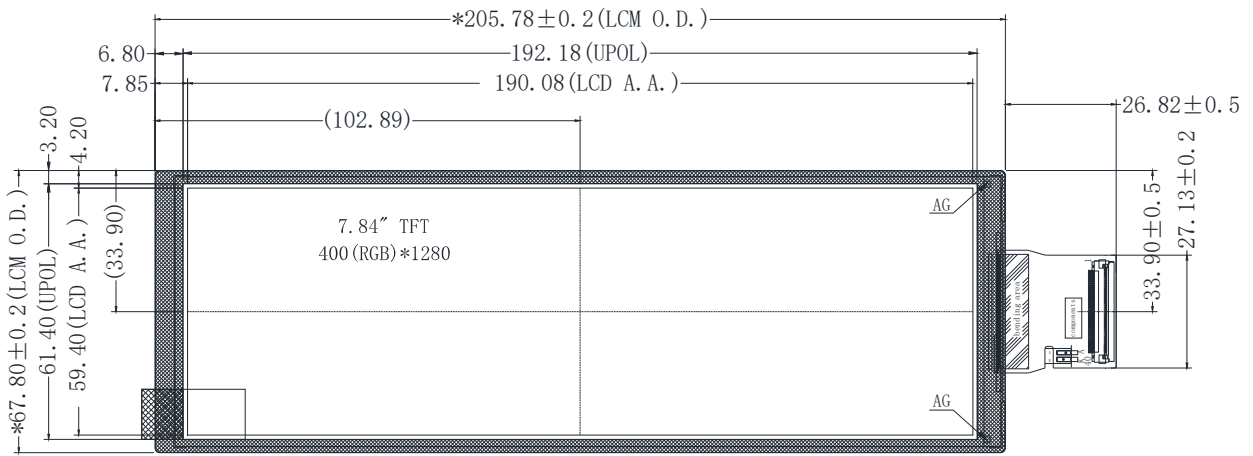

3. INTERFACE SIGNALS

Pin No.	Symbol	Function
1	GND	Ground
2	D0P	MIPI Data lane0 input (positive)
3	D0N	MIPI Data lane0 input (negative)
4	GND	Ground
5	D1P	MIPI Data lane1 input (positive)
6	D1N	MIPI Data lane1 input(negative)
7	GND	Ground
8	CLKP	MIPI CLK input (positive)
9	CLKN	MIPI CLK input (negative)
10	GND	Ground
11	D2P	MIPI Data lane2 input (positive)
12	D2N	MIPI Data lane2 input (negative)
13	GND	Ground
14	D3P	MIPI Data lane3 input (positive)
15	D3N	MIPI Data lane3 input (negative)
16-17	GND	Ground
18-19	IOVCC	IO Power Supply(1.8V)
20-23	NC	NC
24	RSTB	global reset pin. Active low to enter reset state. suggest to connecting with an RC reset circuit for stability. Normally pull high.
25	NC	NC
26	NC	NC
27	GND	Ground
28-29	K	Backlight LED Ground
30	GND	Ground
31	NC	NC
32-33	GND	Ground
34	NC	NC
35-36	A	Backlight LED Power
37	GND	Ground
38-39	VCI	Power Supply(3.3V)
40	NC	NC

Note 1: The MIPI channel selects the BAH register of the driver IC:
 Connect D3P/N to VSS in 3 data lanes application (LANE[1:0]="10").
 Connect D3P/N and D2P/N to VSS in 2 data lanes application (LANE[1:0]="01").

4. ABSOLUTE MAXIMUM RATINGS(TA=25°C)

4.1 ELECTRICAL ABSOLUTE MAXIMUM RATINGS.(VSS=0V ,TA=25°C)

Parameter	Symbol	Condition	Min	Typ	Max	Unit	Note
Power supply	VCI	Ta=25°C	-0.3	-	6.6	V	
I/O and interface power supply	IOVCC	Ta=25°C	-0.3	-	4.5	V	

Notes:

1. If the module is above these absolute maximum ratings. It may become permanently damaged. Using the module within the following electrical characteristic conditions are also exceeded, the module will malfunction and cause poor reliability.
2. $V_{CI} > V_{SS}$ must be maintained.
3. Please be sure users are grounded when handing LCD Module

4.2 ENVIRONMENTAL ABSOLUTE MAXIMUM RATINGS.

Item	Storage		Operating		Note
	MIN.	MAX.	MIN.	MAX.	
Ambient Temperature	-20°C	70°C	-20°C	70°C	1,2

1. The response time will become lower when operated at low temperature.
2. Background color changes slightly depending on ambient temperature.
The phenomenon is reversible.

5. ELECTRICAL SPECIFICATIONS AND INPUT TIMING TABLE

5.1 ELECTRICAL CHARACTERISTICS(VSS=0V ,TA=25°C)

Note:

Parameter		Symbol	Condition	Min	Typ	Max	Unit	Note
Power supply		VCI	Ta=25°C	2.5	2.8	6	V	
Power supply		IOVCC	Ta=25°C	1.65	1.8	3.6	V	
Input voltage	'H'	V _{IH}	V _{IOVCC} =1.8V	0.7V _{IOVCC}	-	V _{IOVCC}	V	
	'L'	V _{IL}	V _{IOVCC} =1.8V	VSS	-	0.3V _{IOVCC}	V	

1:When an optimum contrast is obtained in transmissive mode.

2: Tested in 1×1 chessboard pattern.

5.2 INPUT TIMING TABLE

Parameters	Symbols	Min.	Typ	Max.	Unit
MIPI Vedio data-rate (4 lane)	-	-	382	-	Mbps
PCLK Frequency	FPCLK	-	63.61	-	MHz
Horizontal Synchronization	Hsync	-	2	-	PCLK
Horizontal Back Porch	HBP	-	42	-	PCLK
Horizontal Front Porch	HFP	-	44	-	PCLK
Hsync+ HBP+ HFP	-	-	88*Note1	-	PCLK
Horizontal Address (Display area)	Hadr	-	720	-	PCLK
Horizontal cycle	-	-	12.703	-	us
Vertical Synchronization	Vsync	-	2	-	Line
Vertical Back Porch	VBP	-	14	-	Line
Vertical Front Porch	VFP	-	16	-	Line
Vsync+ VBP+ VFP	-	-	32	-	Line
Vertical Address (Display area)	Vadr	-	1280	-	Line
Vertical cycle	-	-	16.66	16.181	ms
Frame-Rate	-	-	60	61.8	Hz

5.3 LED BACKLIGHT SPECIFICATION(VSS=0V ,TA=25°C)

Item	Symbol	Condition	Min	Typ	Max	Unit	Note
Supply voltage	V_f	-	-	18	-	V	1
Supply current	I_f	-	-	120	-	mA	2
Number of LED	-	6Sx2P	-	12	-	Piece	
LED life time	-		20000	-	-	Hr	

Note:

1: $V_{LED} = V_{LED(+)} - V_{LED(-)}$.

2: The current of LED is 60mA.

A LED drive in constant current mode is recommended.

CIRCUIT DIAGRAM

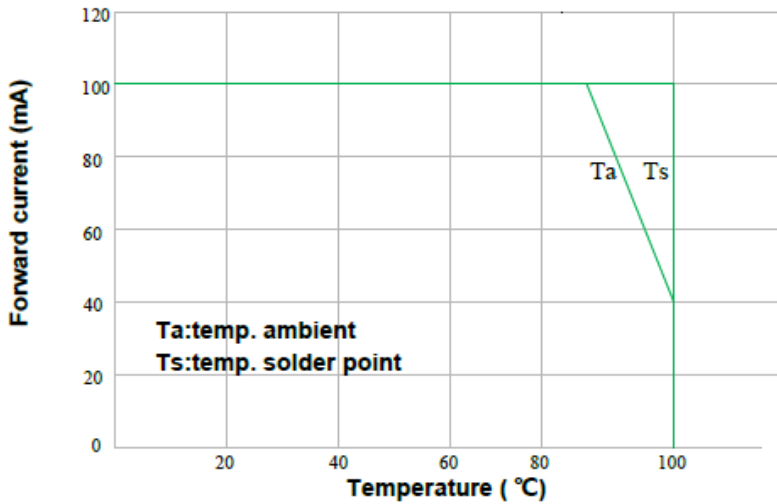

6. OPTICAL CHARACTERISTICS

Item	Symbol	CONDITION	Min.	Typ.	Max.	Unit	Note
Brightness	Bp	$\theta=0^\circ$	400	500	-	cd/m ²	1
Uniformity	ΔBp	$\Phi=0^\circ$	75	80	-	%	1,2
Viewing Angle	3:00	Cr \geq 10	-	80	-	DEG	3
	6:00		-	80	-		
	9:00		-	80	-		
	12:00		-	80	-		
Contrast Ratio	Cr	$\theta=0^\circ$	700	900		-	4
Response Time	T _r +T _f	$\Phi=0^\circ$		30	35	ms	5
Color of CIE Coordinate	W	x	$\theta=0^\circ$ $\Phi=0^\circ$	TBD		-	1,6
		y		TBD		-	
	R	x		TBD		-	
		y		TBD		-	
	G	x		TBD		-	
		y		TBD		-	
	B	x		TBD		-	
		y		TBD		-	
NTSC Ratio	S		65	70	-	%	

Note: The parameter is slightly changed by temperature, driving voltage and materiel

Note 1: The data are measured after LEDs are turned on for 5 minutes. LCM displays full white. The brightness is the average value of 9 measured spots. Measurement equipment BM-7 (Φ 7.5mm)

Measuring condition:

- Measuring surroundings: Dark room.
- Measuring temperature: Ta=25°C.
- Adjust operating voltage to get optimum contrast at the center of the display.

Measured value at the center point of LCD panel after more than 5 minutes while backlight turning on.

Note 1: Definition of viewing angle range

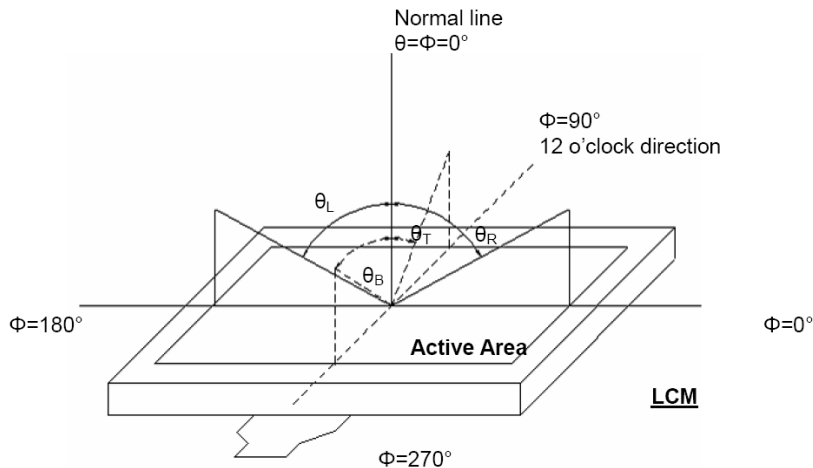

Figure 4.1 Definition of viewing angle.

Note 2: Definition of optical measurement system.

The optical characteristics should be measured in dark room. After 30 minutes operation, the optical properties are measured at the center point of the LCD screen. (Response time is measured by Photo detector TOPCON)

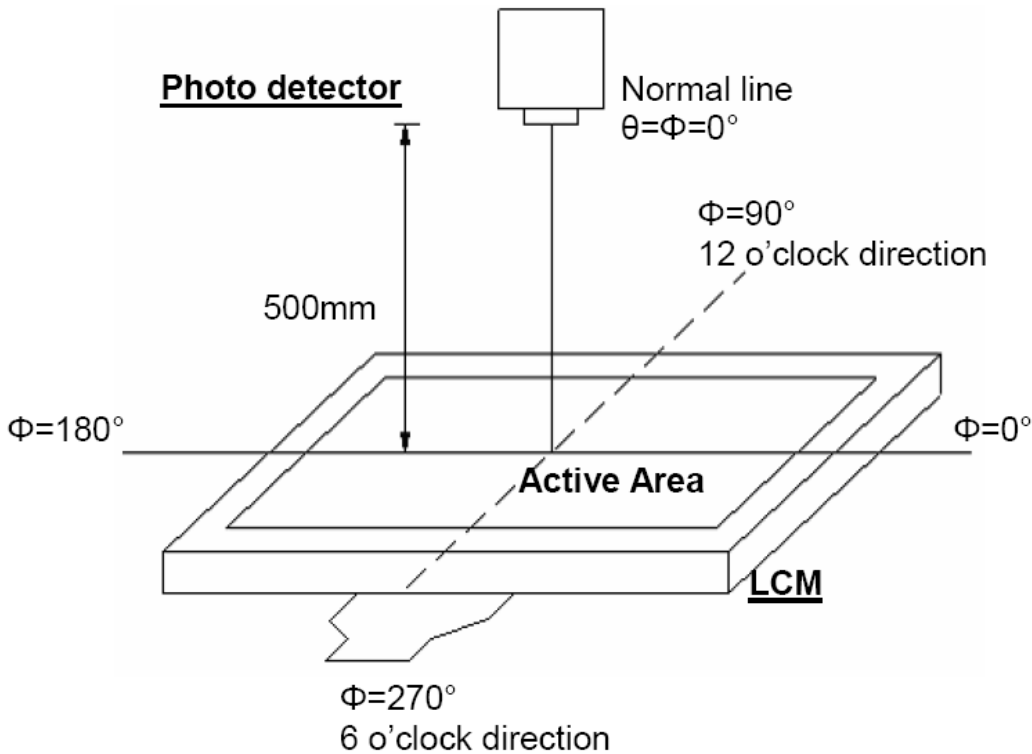

Figure 4.2 Optical measurement system setup

Note 3: Definition of Response time

The response time is defined as the LCD optical switching time interval between "White" state and "Black" state. Rise time (T_{ON}) is the time between photo detector output intensity changed from 90% to 10%. And fall time (T_{OFF}) is the time between photo detector output intensity changed from 10% to 90%.

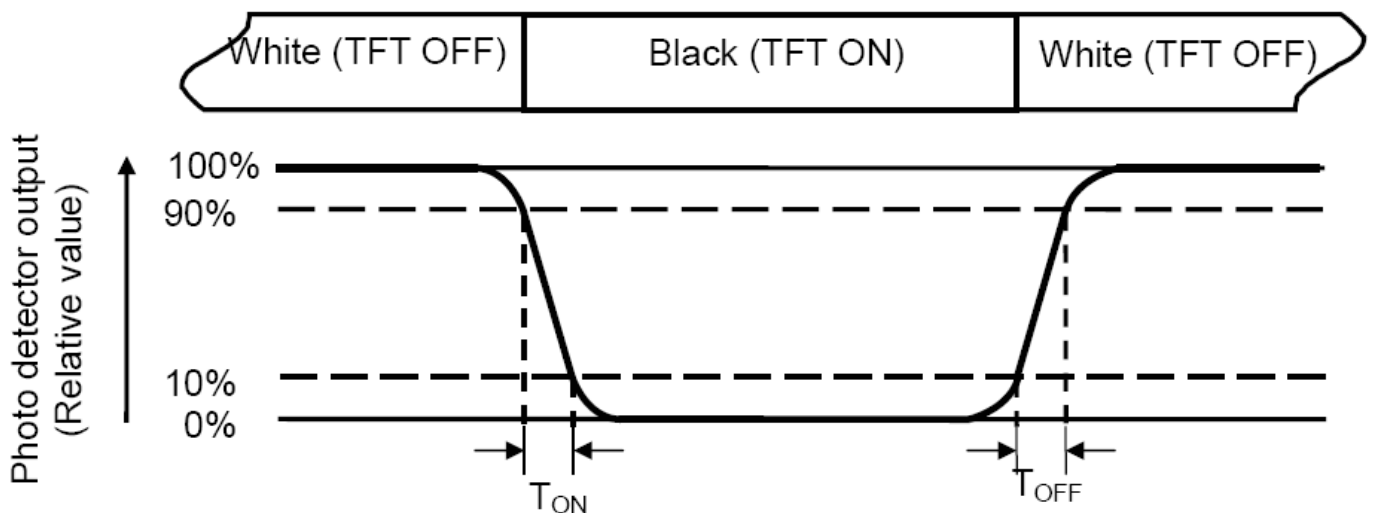

Figure 4.3 Definition of response.

Note 4: Definition of contrast ratio

$$\text{Contrast ratio(CR)} = \frac{\text{Luminance measured when LCD on the "white" state}}{\text{Luminance measured when LCD on the "black" state}}$$

Note 5: Definition of color chromaticity (CIE1931)

Color coordinates measured at center point of LCD.

Note 6: All input terminals LCD panel must be ground while measuring the center area of the panel.

Note 7: Definition of Luminance Uniformity

Active area is divided into 9 measuring areas (Refer to Fig. 4-4).Every measuring point is placed at the center of each measuring area.

$$\text{Luminance Uniformity (Yu)} = \frac{B_{min}}{B_{max}}$$

L-----Active area length W----- Active area width

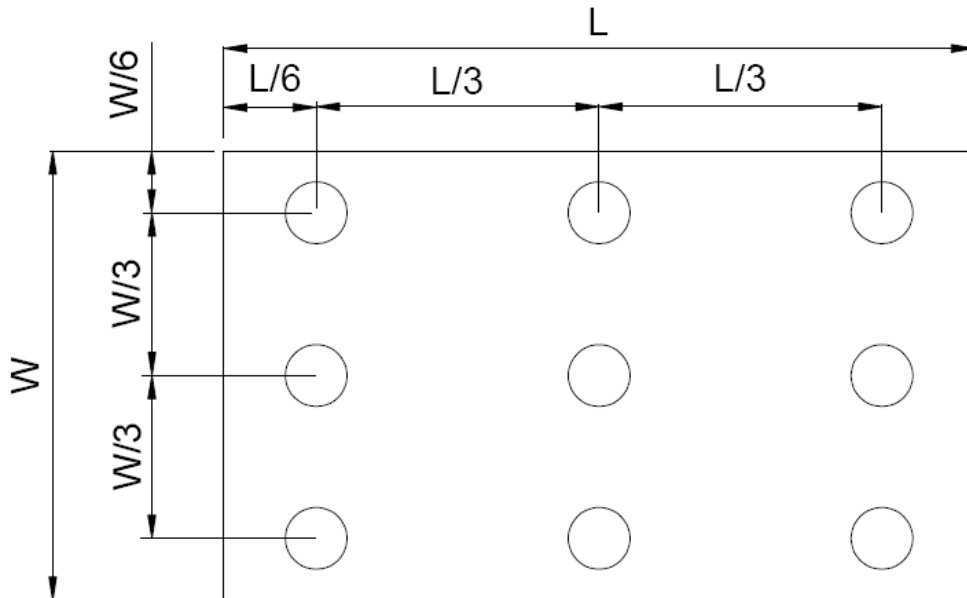

Figure 4.3 Definition of measuring points.

Bmax: The measured maximum luminance of all measurement position.

Bmin: The measured minimum luminance of all measurement position.

7. RELIABILITY TEST ITEMS AND CRITERIA

No	Test Item	Test condition	Criterion
1	High Temperature Storage	70°C 96H Restore 2H at 25°C Power off	1. After testing, cosmetic and electrical defects should not happen. 2. Total current consumption should not be more than twice of initial value.
2	Low Temperature Storage	-20°C 96H Restore 2H at 25°C Power off	
3	High Temperature Operation	70°C 96H Restore 2H at 25°C Power on	
4	Low Temperature Operation	-20°C 96H Restore 4H at 25°C Power on	
5	High Temperature/Humidity Operation	60°C 90%RH 96H Power on	
6	Temperature Cycle	-20°C $\xrightarrow{\hspace{1cm}}$ 70°C 30min 5min 30min After 20 cycle, Restore 2H at 25°C Power off	
7	Package Vibration Test	Random Vibration : 0.015G*G/Hz from 5-200HZ, -6dB/Octave from 200-500HZ 2 hours for each direction of X. Y. Z. (6 hours for total)	Not allowed cosmetic and electrical defects.
8	Mechanical Shock	100G, 6ms, ±X, ±Y, ±Z 3 times for each direction	
9	Electro Static Discharge	Air :±8KV,(150PF,330Ω) Contact:±4KV(150PF,330Ω) Class B(EN 61000-4-2)	

Note: Operation: Supply 3.3V for logic system.

The inspection terms after reliability test, as below

ITEM	Inspection
Contrast	CR>50%
IDD	IDD<200%
Brightness	Brightness>60%
Color Tone	Color Tone+/-0,05

8. PRECAUTION FOR USING LCM

1. When design the product with this LCD Module, make sure the viewing angle matches to its purpose of usage.
2. As LCD panel is made of glass substrate, Dropping the LCD module or banging it against hard objects may cause cracking or fragmentation. Especially at corners and edges.
3. Although the polarizer of this LCD Module has the anti-glare coating, always be careful not to scratch its surface. Use of a plastic cover is recommended to protect the surface of polarizer.
4. If the LCD module is stored at below specified temperature, the LC material may freeze and be deteriorated. If it is stored at above specified temperature, the molecular orientation of the LC material may change to Liquid state and it may not revert to its original state. Excessive temperature and humidity could cause polarizer peel off or bubble. Therefore, the LCD module should always be stored within specified temperature range.
5. Saliva or water droplets must be wiped off immediately as those may leave stains or cause color changes if remained for a long time. Water vapor will cause corrosion of ITO electrodes.
6. If the surface of LCD panel needs to be cleaned, wipe it swiftly with cotton or other soft cloth. If it is not still clean enough, blow a breath on the surface and wipe again.
7. The module should be driven according to the specified ratings to avoid malfunction and permanent damage. Applying DC voltage cause a rapid deterioration of LC material. Make sure to apply alternating waveform by continuous application of the M signal. Especially the power ON/OFF sequence should be kept to avoid latch-up of driver LSIs and DC charge up to LCD panel.
8. Mechanical Considerations
 - a) LCM are assembled and adjusted with a high degree of precision. Avoid excessive shocks and do not make any alterations or modifications. The following should be noted.
 - b) Do not tamper in any way with the tabs on the metal frame.
 - c) Do not modify the PCB by drilling extra holes, changing its outline, moving its components or modifying its pattern.

9. Static Electricity

a) Operator

Wear the electrostatics shielded clothes because human body may be statically charged if not ware shielded clothes. Never touch any of the conductive parts such as the LSI pads; the copper leads on the PCB and the interface terminals with any parts of the human body.

b) Equipment

There is a possibility that the static electricity is charged to the equipment, which has a function of peeling or friction action (ex: conveyer, soldering iron, working table). Earth the equipment through proper resistance (electrostatic earth: 1×10^8 ohm).

Only properly grounded soldering irons should be used.

If an electric screwdriver is used, it should be well grounded and shielded from commutator sparks.

The normal static prevention measures should be observed for work clothes and working benches; for the latter conductive (rubber) mat is recommended.

c) Floor

Floor is the important part to drain static electricity, which is generated by operators or equipment.

There is a possibility that charged static electricity is not properly drained in case of insulating floor. Set the electrostatic earth (electrostatic earth: 1×10^8 ohm).

d) Humidity

Proper humidity helps in reducing the chance of generating electrostatic charges. Humidity should be kept over 50%RH.

e) Transportation/storage

The storage materials also need to be anti-static treated because there is a possibility that the human body or storage materials such as containers may be statically charged by friction or peeling.

The modules should be kept in antistatic bags or other containers resistant to static for storage.

f) Soldering

Soldering anything to this TFT display would void the warranty.

g) Others

The laminator (protective film) is attached on the surface of LCD panel to prevent it from scratches or stains. It should be peeled off slowly using static eliminator.

Static eliminator should also be installed to the workbench to prevent LCD module from static charge.

10. Operation

- a) Driving voltage should be kept within specified range; excess voltage shortens display life.
- b) Response time increases with decrease in temperature.
- c) Display may turn black or dark blue at temperatures above its operational range; this is (however not pressing on the viewing area) may cause the segments to appear "fractured".
- d) Mechanical disturbance during operation (such as pressing on the viewing area) may cause the segments to appear "fractured".

ATM0784L2(AZ DISPLAYS)TFT MODULE VER1.0

11. If any fluid leaks out of a damaged glass cell, wash off any human part that comes into contact with soap and water. The toxicity is extremely low but caution should be exercised at all the time.
12. Disassembling the LCD module can cause permanent damage and it should be strictly avoided.
13. LCD retains the display pattern when it is applied for long time (Image retention). To prevent image retention, do not apply the fixed pattern for a long time. Image retention is not a deterioration of LCD. It will be removed after display pattern is changed.
14. Do not use any materials, which emit gas from epoxy resin (hardener for amine) and silicone adhesive agent (dealcohol or deoxym) to prevent discoloration of polarizer due to gas.
15. Avoid the exposure of the module to the direct sunlight or strong ultraviolet light for a long time.

9.PACKAGE DRAWING

TBD

10.INSPECTION SPECIFICATION

1. SCOPE SPECIFICATIONS CONTAIN

- 1.1 DISPLAY QUALITY EVALUATION
- 1.2 MECHANICS SPECIFICATION

2. SAMPLING PLAN

UNLESS THERE IS OTHER AGREEMENT, THE SAMPLING PLAN FOR INCOMING INSPECTION SHALL FOLLOW MIL-STD-105E.

- 2.1 LOT SIZE: QUANTITY PER SHIPMENT AS ONE LOT (DIFFERENT MODEL AS DIFFERENT LOT).
- 2.2 SAMPLING TYPE: NORMAL INSPECTION, SINGLE SAMPLING.
- 2.3 SAMPLING LEVEL: LEVEL II.
- 2.4 AQL: ACCEPTABLE QUALITY LEVEL
 - MAJOR DEFECT: AQL=0.65
 - MINOR DEFECT: AQL=1.0

3. PANEL INSPECTION CONDITION

- 3.1 ENVIRONMENT:
 - ROOM TEMPERATURE: 25±5°C.
 - HUMIDITY: 65±5% RH.
 - ILLUMINATION: 300 ~ 700 LUX.
- 3.2 INSPECTION DISTANCE:
 - 35±5 CM
- 3.3 INSPECTION ANGLE:
 - THE VISION OF INSPECTOR SHOULD BE PERPENDICULAR TO THE SURFACE OF THE MODULE.
- 3.4 INSPECTION TIME:
 - PERCEPTIBILITY TEST TIME: 20 SECONDS MAX.

4. DISPLAY QUALITY



- 4.1 FUNCTION RELATED:
 - THE FUNCTION DEFECTS OF LINE DEFECT, ABNORMAL DISPLAY, AND NO DISPLAY ARE CONSIDERED MAJOR DEFECTS.
- 4.2 BRIGHT/DARK DOTS:

Defect Type	Specification	Major	Minor
Bright Dots	$N \leq 2$		●
Dark Dots	$N \leq 3$		●
Total Bright and Dark Dots	$N \leq 4$		●

Note: 1:

The definition of dot: The size of a defective dot over 1/2 of whole dot is regarded as one defective dot.
 Bright dot: Dots appear bright and unchanged in size in which LCD panel is displaying under black pattern.
 The bright dot defect must be visible through 2% ND filter
 Dark dot: Dots appear dark and unchanged in size in which LCD panel is displaying under pure red, green, blue pattern.

4.3 Pixel Definition:

R	G	B	R	G	B	R	G	B			Dot Defect
R	G	B	R	G	B	R	G	B			Adjacent Dot Defect
R	G	B	R	G	B	R	G	B			Cluster

Note 1:

If pixel or partial sub-pixel defects exceed 50% of the affected pixel or sub-pixel area, it shall be considered as 1 defect.

Note 2:

There should be no distinct non-uniformity visible through 2% ND Filter within 2 sec inspection times.

ATM0784L2(AZ DISPLAYS)TFT MODULE VER1.0

4.4 Visual Inspection specifications:

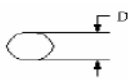
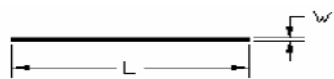
<u>Defect Type</u>		<u>Specification Size</u>	<u>Count(N)</u>	Major	Minor	
Dot Shape (Particle · Scratch and Bubbles in display area) 		$D \leq 0.25 \text{ mm}$	Ignored			
		$0.25\text{mm} < D \leq 0.5\text{mm}$	$N \leq 3$		•	
		$D > 0.5\text{mm}$	$N=0$			
Newton Ring (Only for Touch panel)		$D \leq 70\text{mm}$	$N \leq 4$		•	
		$D > 70\text{mm}$	$N=0$			
TSP Fish Eyes (Only for Touch panel) (Bubble/Dent)		$0.1\text{mm} < D \leq 0.2\text{mm}$	$N \leq 4$			
		$0.2\text{mm} < D \leq 0.3\text{mm}$	$N \leq 3$		•	
		$0.3 < D \leq 0.4$	$N \leq 2$			
Line Shape (Particles · Scratch · Lint and Bubbles in display area) 		$W \leq 0.01 \text{ mm}$	Ignored			
		$0.01\text{mm} < W \leq 0.05\text{mm}$ and $L \leq 3\text{mm}$	$N \leq 3$		•	
		$W > 0.05\text{mm}$ or $L > 3 \text{ mm}$	$N=0$			
Bubble in cell (active area)		It should be found by eyes			•	
Bezel	Scratch	No harm			•	
	Dirt				•	
	Wrap				•	
	Sunken				•	
Label	No label	No			•	
	Inverted label				•	
	Broken				•	
	Dirt			Word can be read.		•
	Not clear					•
	Word out of shape			No		•
	Mistake			No		•
	Position			Be attached on right position		•
Screw	Not enough	No			•	
	Limp	No			•	

ATM0784L2(AZ DISPLAYS)TFT MODULE VER1.0

Connector	Connection status	No bend on pins and damage		•
FPC/FFC	Broken	No		•

Note: Extraneous substance and scratch not affecting the display of image, for instance, extraneous substance under polarizer film but outside the display area, or scratch on metal bezel and backlight module or polarizer film outside the display area, shall not be considered as defective or non-conforming.