

AZ DISPLAYS

SPECIFICATIONS FOR LIQUID CRYSTAL DISPLAY

| CUSTOMER APPROVAL | | | |
|---|--|-----------------|--|
| | | | |
| ※ PART NO. : <u>ATM0350D18A (AZ DISPLAYS) SPEC V1.0</u> | | | |
| APPROVAL | | COMPANY CHOP | |
| CUSTOMER COMMENTS | | | |

| AZ DISPLAYS ENGINEERING APPROVAL | | |
|----------------------------------|------------|-------------|
| DESIGNED BY | CHECKED BY | APPROVED BY |
| | | |

REVISION RECORD

| REVISION | REVISION DATE | PAGE | CONTENTS |
|---------------|------------------|------|--------------------|
| VER1.0 | 2014-6-27 | | FIRST ISSUE |

※ **CONTENTS**

1. GENERAL SPECIFICATIONS
2. PIN ASSIGNMENT
3. OPERATING SPECIFICATIONS
4. OPTICAL SPECIFICATIONS
5. RELIABILITY TEST
6. PRECAUTION FOR USING LCM
7. MECHANICAL DRAWING
8. PACKAGE DRAWING
9. INSPECTION SPECIFICATION

1. GENERAL SPECIFICATIONS

| Item | Specification | Remark |
|---------------------------------|----------------------------------|--------|
| 1. LCD size | 3.5 inch(Diagonal) | |
| 2. Driver element | a-Si TFT active matrix | |
| 3. Resolution | 320x(RGB)x240 | |
| 4. Display mode | Normally white, Transmissive | |
| 5. Dot Pitch (W*H) | 0.073mm(W) x 0.219mm(H) | |
| 6. Active Area(W*H) | 70.08mm(W) x 52.56mm(H) | |
| 7. Module size (W*H) | 76.8mm(W) x 63.8mm(H) x 3.3mm(D) | Note 1 |
| 8. Surface treatment | Anti-glare | |
| 9. Color arrangement | RGB-stripe | |
| 10. Driver IC | HX8238-D | |
| 11. Backlight power consumption | 0.396W(Typ.) | |
| 12. Panel power consumption | 0.038W(Typ.). | |
| 13. Weight | T.B.D. | |
| 14. RoHS | RoHS compliant | |

Note 1: Please refer to mechanical drawing.

2. PIN ASSIGNMENT

TFT LCD Panel Driving Section

FPC Connector is used for the module electronics interface. The recommended model is "04 6299 050" series manufactured by Kyocera.

| Pin No. | Symbol | Function | Level | Note |
|---------|--------|----------------------------------|-------|------|
| 1-2 | VBL- | Power for LED backlight(Cathode) | P | |
| 3-4 | VBL+ | Power for LED backlight(Anode) | P | |
| 5 | NC | Not use | -- | |
| 6 | /RESET | Hardware reset | I | |
| 7 | CSB | SPI Interface chip select bar | I | |
| 8 | SCK | SPI interface data clock | I | |
| 9 | SDI | SPI interface data input | I | |
| 10 | SDO | SPI interface data output | O | |
| 11~18 | B7~B0 | Blue data | I | |
| 19~26 | G7~G0 | Green data | I | |
| 27~34 | R7~R0 | Red data | I | |
| 35 | DCLK | Dot data clock | I | |
| 36 | HSYNC | Horizontal sync input | I | |
| 37 | VSYNC | Vertical sync input | I | |
| 38 | ENB | Data enable input | I | |
| 39-40 | VDD | Analog power | P | |
| 41-42 | VCC | Digital power | P | |
| 43-46 | NC | Not use | -- | |
| 47 | SHUT | Display shut donw pin | I | |
| 48 | NC | Not use | -- | |
| 49-50 | VSS | Ground | P | |

I: input, O: output, P: Power

3. Operating Specification

3.1 ABSOLUTE MAXIMUM RATINGS

| Item | Symbol | Values | | Unit | Remark |
|-----------------------|----------|--------|------|------|--------------------|
| | | Min. | Max. | | |
| Power Voltage | V_{DD} | -0.3 | 5.0 | V | |
| Operation Temperature | T_{OP} | -20 | 70 | °C | |
| Storage Temperature | T_{ST} | -30 | 80 | °C | |
| LED Reverse Voltage | V_R | - | 1.2 | V | Each LED Note 2 |
| LED Forward Current | I_F | | 25 | mA | Each LED |

Note 1: The absolute maximum rating values of this product are not allowed to be exceeded at any times. Should a module be used with any of the absolute maximum ratings exceeded, the characteristics of the module may not be recovered, or in an extreme case, the module may be permanently destroyed.

Note 2: V_R Conditions: Zener Diode 20mA

3.2 Typical Operation Conditions

| Item | Symbol | Values | | | Unit | Remark |
|--------------------------|----------|--------|------|--------|------|--------|
| | | Min. | Typ. | Max. | | |
| Power Voltage | V_{DD} | 2.5 | 3.3 | 3.6 | V | Note 1 |
| Input Logic High Voltage | V_{IH} | 0.8VCC | -- | VCC | V | Note 2 |
| Input Logic Low Voltage | V_{IL} | 0 | -- | 0.2VCC | V | Note 2 |

Note 1: V_{DD} setting should match the signals output voltage of customer's system board.

Note 2: DCLK,HS,VS,RESET,DE,R0~R7,G0~G7,B0~B7.

3.3 Backlight driving conditions

| Item | Symbol | Values | | | Unit | Remark |
|---------------------------|--------|--------|------|------|------|--------|
| | | Min. | Typ. | Max. | | |
| Voltage for LED Backlight | V_L | 18 | 19.8 | 21.6 | V | Note 1 |
| Current for LED Backlight | I_L | 18 | 20 | 22 | mA | |
| LED life time | -- | 30000 | -- | -- | Hr | Note 2 |

Note 1: The LED Supply Voltage is defined by the number of LED at $T_a=25^\circ\text{C}$ and $I_L=20\text{mA}$.

Note 2: The "LED life time" is defined as the module brightness decrease to 50% original brightness at $T_a=25^\circ\text{C}$ and $I_L=20\text{mA}$.

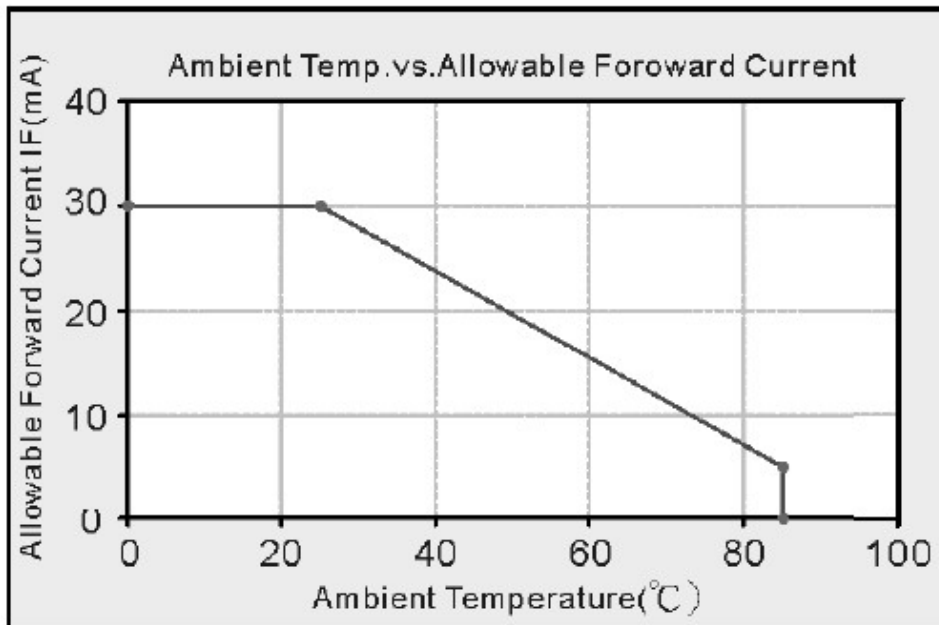

3.4 Timing Characteristics

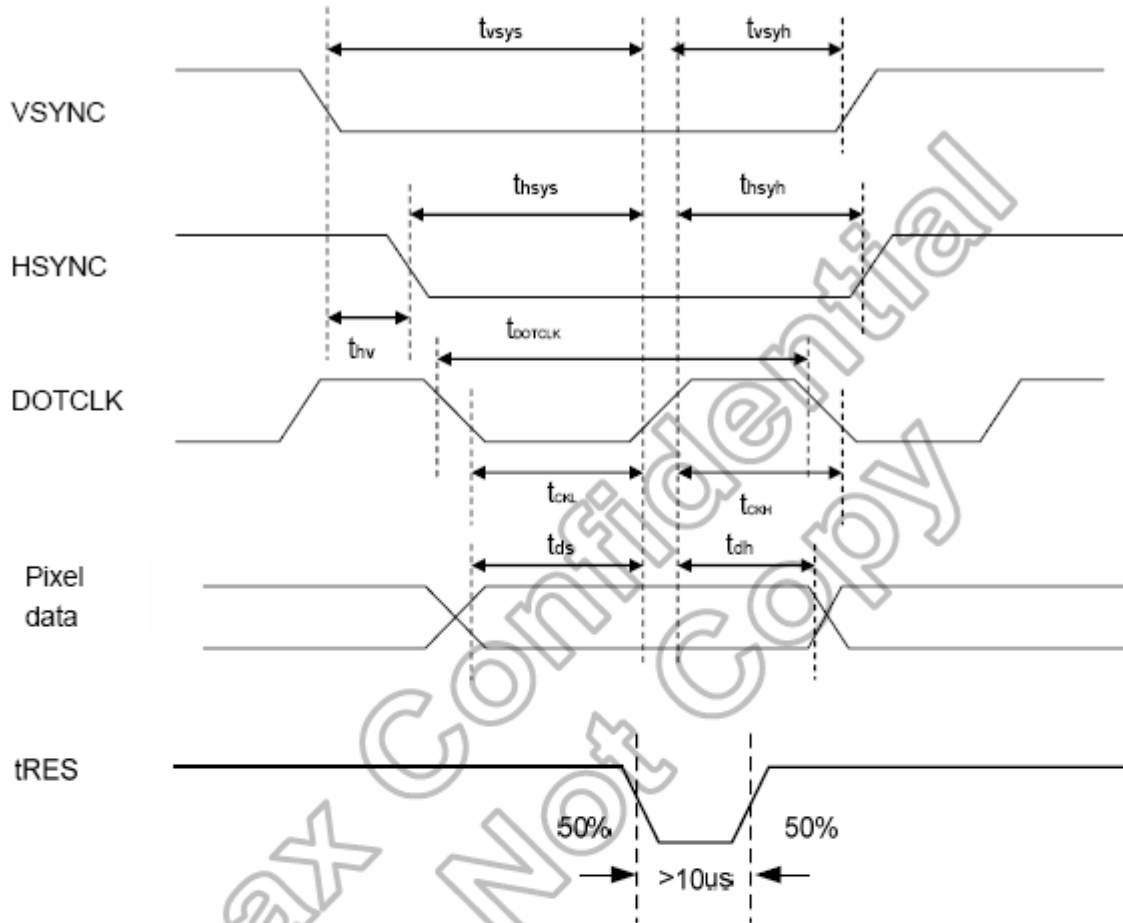
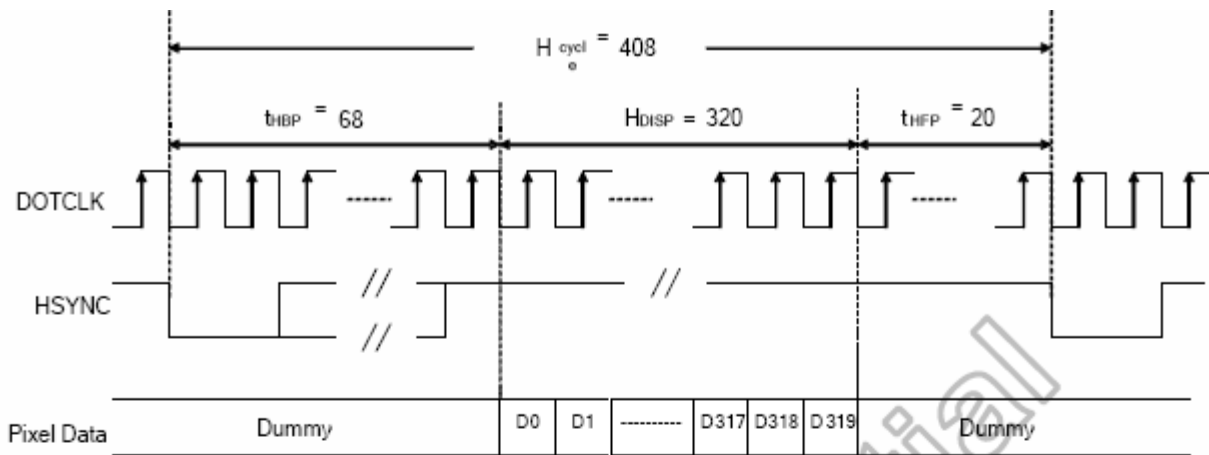

Figure 12. 1 Pixel Timing

| Characteristics | Symbol | Min. | | Typ. | | Max. | | Unit |
|--|---------|--------|-------|--------|-------|--------|-------|---------|
| | | 24 bit | 8 bit | 24 bit | 8 bit | 24 bit | 8 bit | |
| DOTCLK Frequency | fDOTCLK | - | - | 6.5 | 19.5 | 10 | 30 | MHz |
| DOTCLK Period | tDOTCLK | 100 | 33.3 | 154 | 51.3 | - | - | ns |
| Vertical Sync Setup Time | tvsys | 20 | 10 | - | - | - | - | ns |
| Vertical Sync Hold Time | tvsyh | 20 | 10 | - | - | - | - | ns |
| Horizontal Sync Setup Time | thsys | 20 | 10 | - | - | - | - | ns |
| Horizontal Sync Hold Time | thsyh | 20 | 10 | - | - | - | - | ns |
| Phase difference of Sync Signal Falling Edge | thv | 1 | | - | | 240 | | tDOTCLK |
| DOTCLK Low Period | tCKL | 50 | 15 | - | - | - | - | ns |
| DOTCLK High Period | tCKH | 50 | 15 | - | - | - | - | ns |
| Data Setup Time | tds | 12 | 10 | - | - | - | - | ns |
| Data hold Time | tdh | 12 | 10 | - | - | - | - | ns |
| Reset pulse width | tRES | 10 | | - | | - | | μs |

Note: External clock source must be provided to DOTCLK pin of HX8238-D. The driver will not operate if absent of the clocking signal.

Table 12. 1 Pixel Timing



(a) Horizontal Data Transaction Timing

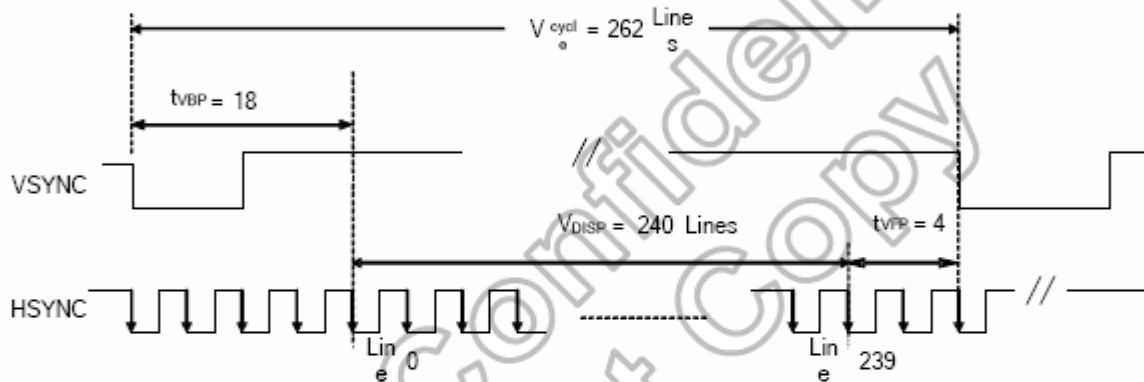

(b) Vertical Data Transaction Timing

Figure 12. 2 Data Transaction Timing in Parallel RGB (24 bit) Interface (SYNC Mode)

| Characteristics | Symbol | Min. | | Typ. | | Max. | | Unit |
|------------------------------|-------------------------------------|--------|-------|-------------|-------|--------|-------|---------------------|
| | | 24 bit | 8 bit | 24 bit | 8 bit | 24 bit | 8 bit | |
| DOTCLK Frequency | f _{DOTCLK} | - | - | 6.5 | 19.5 | 10 | 30 | MHz |
| DOTCLK Period | t _{DOTCLK} | 100 | 33.3 | 154 | 51.3 | - | - | ns |
| Horizontal Frequency (Line) | f _H | - | - | 14.9 | | 22.35 | | KHz |
| Vertical Frequency (Refresh) | f _V | - | - | 60 | | 90 | | Hz |
| Horizontal Back Porch | t _{HBP} | - | - | 68 | 204 | - | - | t _{DOTCLK} |
| Horizontal Front Porch | t _{HFP} | - | - | 20 | 60 | - | - | t _{DOTCLK} |
| Horizontal Data Start Point | t _{HBP} | - | - | 68 | 204 | - | - | t _{DOTCLK} |
| Horizontal Blanking Period | t _{HBP} + t _{HFP} | - | - | 88 | 264 | - | - | t _{DOTCLK} |
| Horizontal Display Area | H _{DISP} | - | - | 320 | 960 | - | - | t _{DOTCLK} |
| Horizontal Cycle | H _{cycle} | - | - | 408 | 1224 | 450 | 1350 | t _{DOTCLK} |
| Vertical Back Porch | t _{VBP} | - | - | 18 | | - | | Lines |
| Vertical Front Porch | t _{VFP} | - | - | 4 | | - | | Lines |
| Vertical Data Start Point | t _{VBP} | - | - | 18 | | - | | Lines |
| Vertical Blanking Period | t _{VBP} + t _{VFP} | - | - | 22 | | - | | Lines |
| Vertical Display Area | NTSC | - | | 240 | | - | | Lines |
| | PAL | - | | 280(PALM=0) | | - | | |
| | PAL | - | | 288(PALM=1) | | - | | |
| Vertical Cycle | NTSC | - | | 262 | | 350 | | Lines |
| | PAL | - | | 313 | | - | | |

Table 12. 2 Data Transaction Timing in Normal Operating Mode

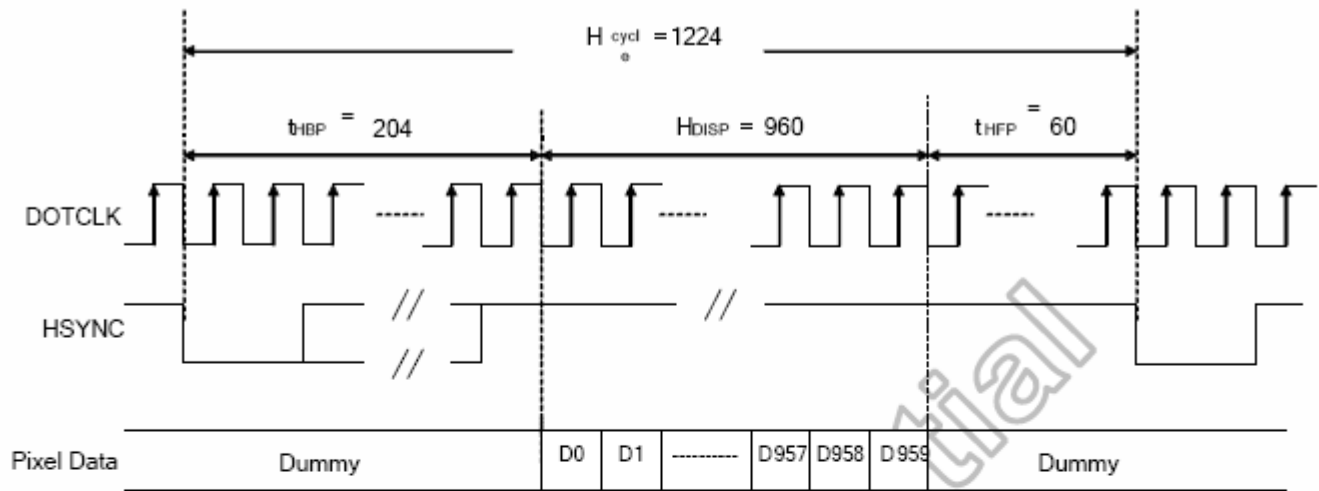

(1) Horizontal Data Transaction Timing

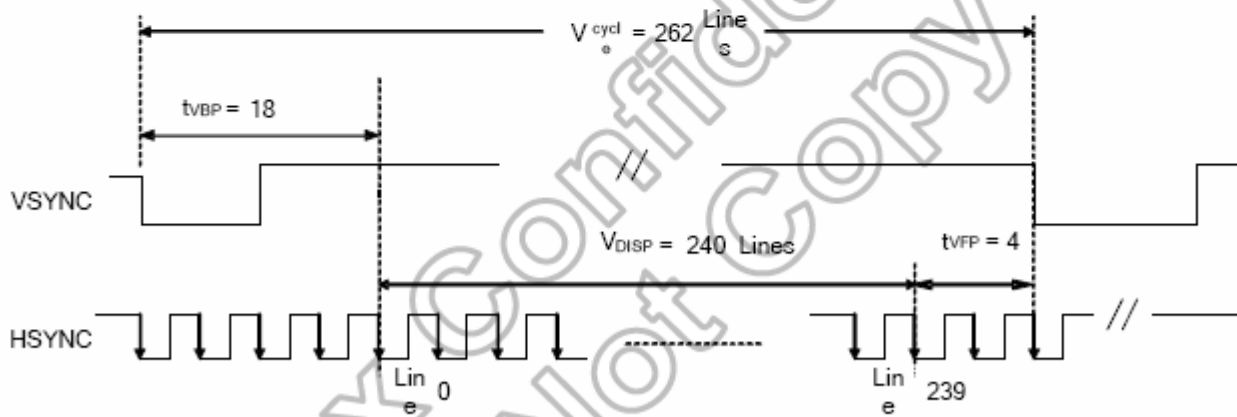

(2) Vertical Data Transaction Timing

Figure 12.3 Data Transaction Timing in Serial RGB (8 bit) Interface (SYNC Mode)

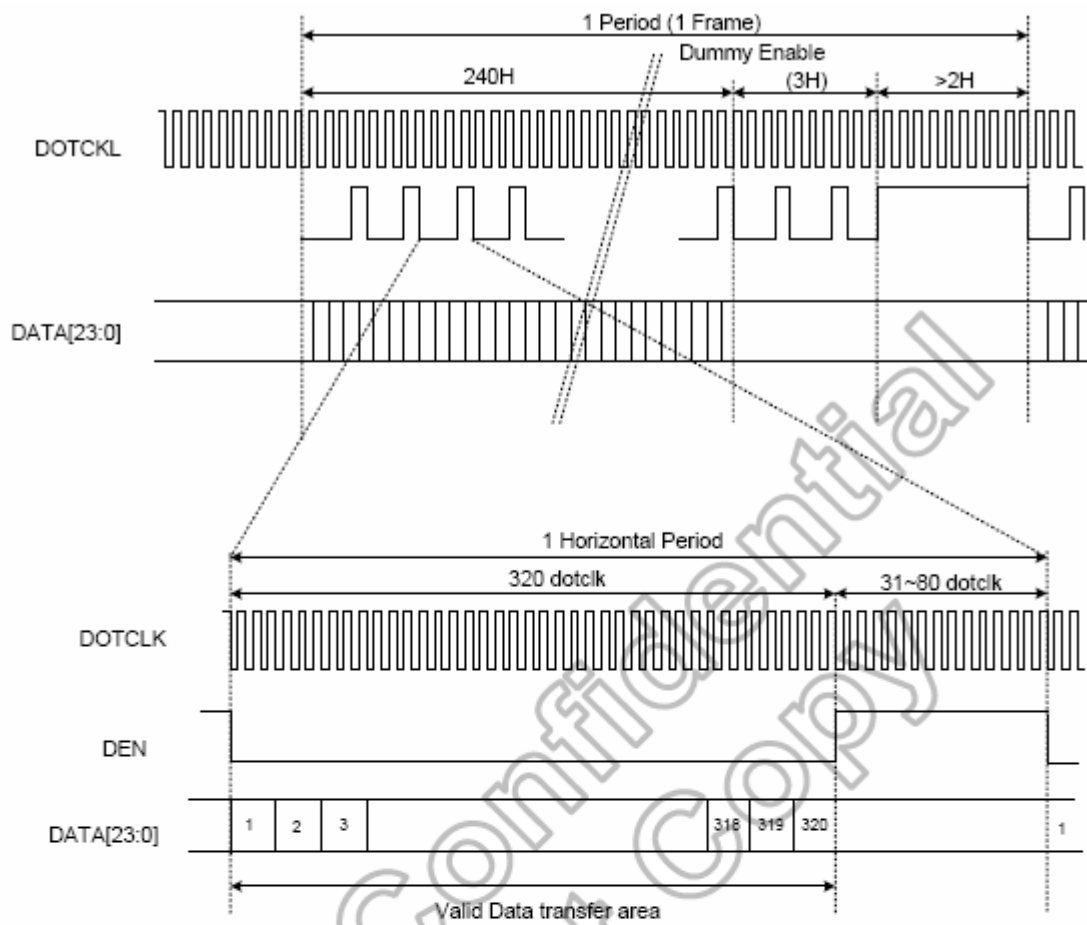
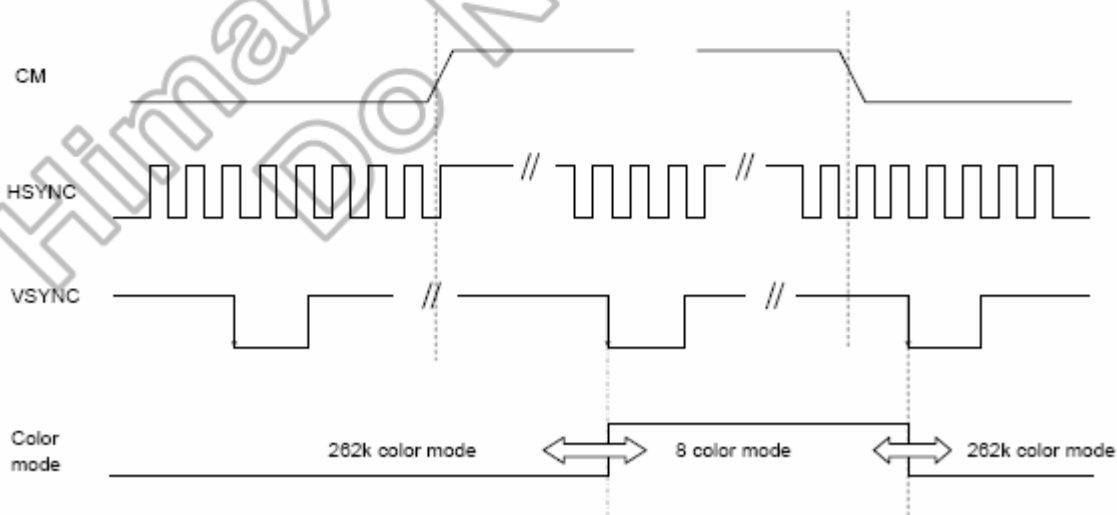

Figure 12. 4 Signal Timing in DE Mode



Note: The color mode conversion starts at the first falling edge of VSYNC after stage change of CM.

Figure 12. 5 Color Mode Conversion Timing

4.0 OPTICAL SPECIFICATIONS

| Item | Symbol | Condition | Values | | | Unit | Remark |
|--------------------------|--------------------|---------------------------------|--------|------|------|-------------------|------------------|
| | | | Min. | Typ. | Max. | | |
| Viewing Angle (CR≥10) | θ_L | $\Phi=180^\circ$ (9 O'CLOCK) | 70 | 80 | -- | degree | Note 1 |
| | θ_R | $\Phi=0^\circ$ (3 O'CLOCK) | 70 | 80 | -- | | |
| | θ_T | $\Phi=90^\circ$ (12 O'CLOCK) | 70 | 80 | -- | | |
| | θ_B | $\Phi=270^\circ$ (6 O'CLOCK) | 70 | 80 | -- | | |
| Response Time | $T_{ON} + T_{OFF}$ | Normal $\Theta=\Phi=0^\circ$ | -- | 50 | 70 | msec | Note 3 |
| Contrast Ratio | CR | | 350 | 450 | -- | -- | Note 4 |
| Color Chromaticity | W_X | | 0.26 | 0.31 | 0.36 | -- | Note 2 |
| | W_Y | | 0.26 | 0.31 | 0.36 | -- | Note 5 Note 6 |
| Luminance | L | | 280 | 320 | -- | cd/m ² | Note 6 |
| Luminance Uniformity | YU | | 70 | 80 | -- | % | Note 7 |

Test Conditions:

- VCC=3.3V, IL=20mA (Backlight current), the ambient temperature is 25°C.
- The test systems refer to Note 2.

Note 1: Definition of viewing angle range

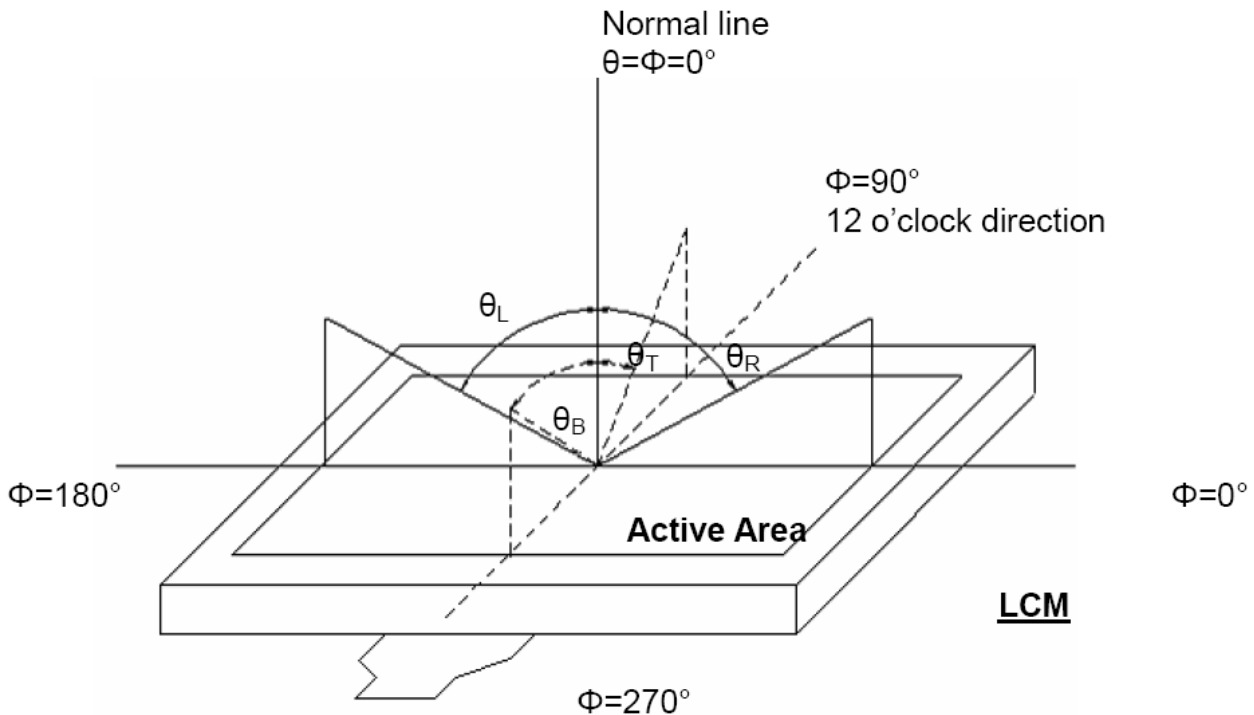

Figure 4.1 Definition of viewing angle.

Note 2: Definition of optical measurement system.

The optical characteristics should be measured in dark room. After 30 minutes operation, the optical properties are measured at the center point of the LCD screen. (Response time is measured by Photo detector TOPCON)

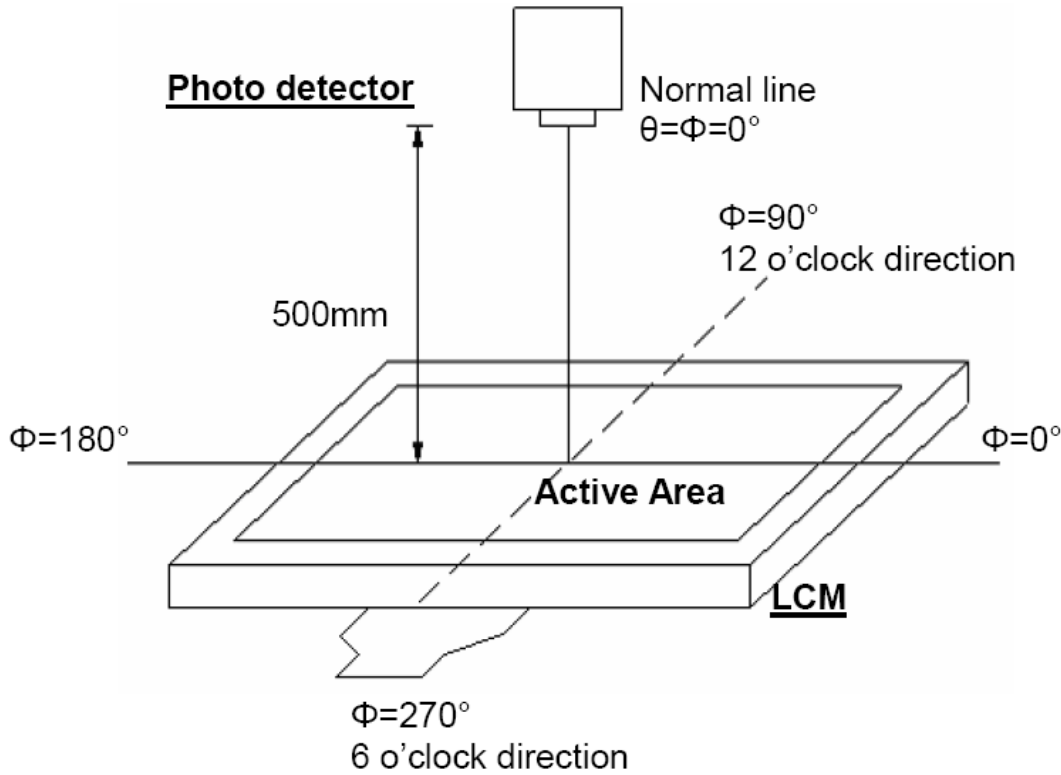

Figure 4.2 Optical measurement system setup

Note 3: Definition of Response time

The response time is defined as the LCD optical switching time interval between "White" state and "Black" state. Rise time (T_{ON}) is the time between photo detector output intensity changed from 90% to 10%. And fall time (T_{OFF}) is the time between photo detector output intensity changed from 10% to 90%.

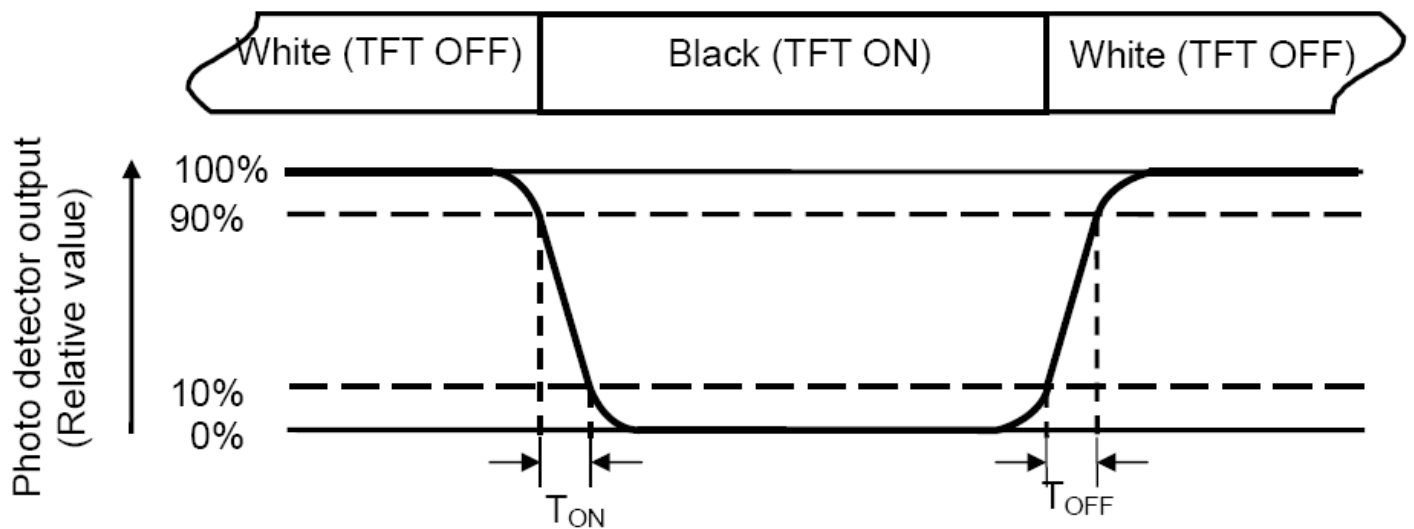

Figure 4.3 Definition of response.

Note 4: Definition of contrast ratio

$$\text{Contrast ratio(CR)} = \frac{\text{Luminance measured when LCD on the "white" state}}{\text{Luminance measured when LCD on the "black" state}}$$

Note 5: Definition of color chromaticity (CIE1931)

Color coordinates measured at center point of LCD.

Note 6: All input terminals LCD panel must be ground while measuring the center area of the panel. The LED driving condition is $I_L=20\text{mA}$.

Note 7: Definition of Luminance Uniformity

Active area is divided into 9 measuring areas (Refer to Fig. 4-4).Every measuring point is placed at the center of each measuring area.

$$\text{Luminance Uniformity (Yu)} = \frac{B_{min}}{B_{max}}$$

L-----Active area length W----- Active area width

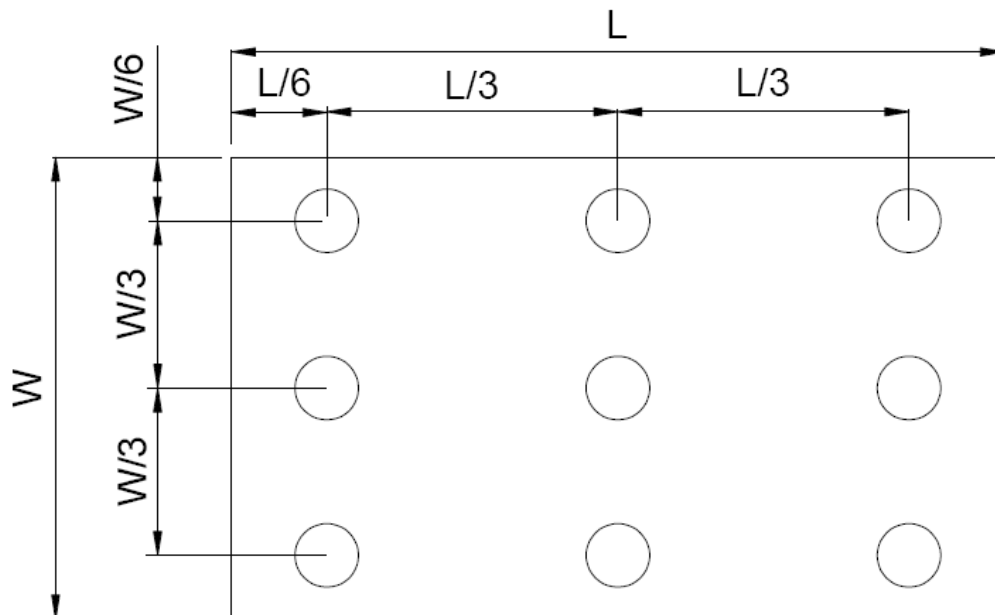

Figure 4.3 Definition of measuring points.

Bmax: The measured maximum luminance of all measurement position.

Bmin: The measured minimum luminance of all measurement position.

5. RELIABILITY TEST

| Item | Test Condition Item | Remark |
|--|--|------------------|
| High temperature storage | Ta= 80 °C 240hrs | Note 1 Note 4 |
| Low temperature storage | Ta=-30 °C 240hrs | Note 1 Note 4 |
| High temperature operation | Ts= 70 °C 240hrs | Note 2 Note 4 |
| Low temperature operation | Ts=-20 °C 240hrs | Note 1 Note 4 |
| High temperature/High humidity operation | 90% RH 60°C 240hrs | Note 4 |
| Thermal Shock | -30°C/30 min ~ +80°C/30 min for a total 100 cycles, Start with cold temperature and end with high temperature. | Note 4 |
| Vibration test | Freq:10~55~10Hz Amplitude:1.5mm 2 hours for each direction of X,Y,Z (6 hours for total) | |
| Mechanical shock | 100G 6ms,±X, ±Y, ±Z 3 times for each direction | |
| Package vibration test | Random Vibration : 0.015G*G/Hz from 5-200HZ, -6dB/Octave from 200-500HZ 2 hours for each direction of X. Y. Z. (6 hours for total) | |
| Package drop test | Height:60 cm 1 corner, 3 edges, 6 surfaces | |
| Electro static discharge | ± 2KV, Human Body Mode, 100pF/1500Ω | |

Note 1: Ta is the ambient temperature of samples.

Note 2: Ts is the temperature of panel's surface.

Note 3: In the standard condition, there shall be no practical problem that may affect the display function. After the reliability test, the product only guarantees operation, but don't guarantee all of the cosmetic specification.

Note 4: Before cosmetic and function test, the product must have enough recovery time, at least 2 hours at room temperature.

6. PRECAUTION FOR USING LCM

1. When design the product with this LCD Module, make sure the viewing angle matches to its purpose of usage.
2. As LCD panel is made of glass substrate, Dropping the LCD module or banging it against hard objects may cause cracking or fragmentation. Especially at corners and edges.
3. Although the polarizer of this LCD Module has the anti-glare coating, always be careful not to scratch its surface. Use of a plastic cover is recommended to protect the surface of polarizer.
4. If the LCD module is stored at below specified temperature, the LC material may freeze and be deteriorated. If it is stored at above specified temperature, the molecular orientation of the LC material may change to Liquid state and it may not revert to its original state. Excessive temperature and humidity could cause polarizer peel off or bubble. Therefore, the LCD module should always be stored within specified temperature range.
5. Saliva or water droplets must be wiped off immediately as those may leave stains or cause color changes if remained for a long time. Water vapor will cause corrosion of ITO electrodes.
6. If the surface of LCD panel needs to be cleaned, wipe it swiftly with cotton or other soft cloth. If it is not still clean enough, blow a breath on the surface and wipe again.
7. The module should be driven according to the specified ratings to avoid malfunction and permanent damage. Applying DC voltage cause a rapid deterioration of LC material. Make sure to apply alternating waveform by continuous application of the M signal. Especially the power ON/OFF sequence should be kept to avoid latch-up of driver LSIs and DC charge up to LCD panel.
8. Mechanical Considerations
 - a) LCM are assembled and adjusted with a high degree of precision. Avoid excessive shocks and do not make any alterations or modifications. The following should be noted.
 - b) Do not tamper in any way with the tabs on the metal frame.
 - c) Do not modify the PCB by drilling extra holes, changing its outline, moving its components or modifying its pattern.
 - d) Do not touch the elastomer connector; especially insert a backlight panel (for example, EL).
 - e) When mounting a LCM makes sure that the PCB is not under any stress such as bending or twisting. Elastomer contacts are very delicate and missing pixels could result from slight dislocation of any of the elements.
 - f) Avoid pressing on the metal bezel, otherwise the elastomer connector could be deformed and lose contact, resulting in missing pixels.
9. Static Electricity
 - a) Operator

Wear the electrostatics shielded clothes because human body may be statically charged if not ware shielded clothes. Never touch any of the conductive parts such as the LSI pads; the copper leads on the PCB and the interface terminals with any parts of the human body.
 - b) Equipment

There is a possibility that the static electricity is charged to the equipment, which has a function of peeling or friction action (ex: conveyer, soldering iron, working table). Earth the equipment through proper resistance (electrostatic earth: 1×10^8 ohm).
Only properly grounded soldering irons should be used.
If an electric screwdriver is used, it should be well grounded and shielded from commutator sparks.
The normal static prevention measures should be observed for work clothes and working benches; for the latter conductive (rubber) mat is recommended.
 - c) Floor

Floor is the important part to drain static electricity, which is generated by operators or equipment.
There is a possibility that charged static electricity is not properly drained in case of insulating floor. Set the electrostatic earth (electrostatic earth: 1×10^8 ohm).
 - d) Humidity

Proper humidity helps in reducing the chance of generating electrostatic charges. Humidity should be kept over 50%RH.
 - e) Transportation/storage

The storage materials also need to be anti-static treated because there is a possibility that the human body or storage materials such as containers may be statically charged by friction or peeling.
The modules should be kept in antistatic bags or other containers resistant to static for storage.
 - f) Soldering

Solder only to the I/O terminals. Use only soldering irons with proper grounding and no leakage.
Soldering temperature : $280^{\circ} \text{C} \pm 10^{\circ} \text{C}$
Soldering time: 3 to 4 sec.
Use eutectic solder with resin flux fill.
If flux is used, the LCD surface should be covered to avoid flux spatters. Flux residue should be removed afterwards.
 - g) Others

The laminator (protective film) is attached on the surface of LCD panel to prevent it from scratches or stains. It should be peeled off slowly using static eliminator.

Static eliminator should also be installed to the workbench to prevent LCD module from static charge.

10. Operation

- a) Driving voltage should be kept within specified range; excess voltage shortens display life.
 - b) Response time increases with decrease in temperature.
 - c) Display may turn black or dark blue at temperatures above its operational range; this is (however not pressing on the viewing area) may cause the segments to appear "fractured".
 - d) Mechanical disturbance during operation (such as pressing on the viewing area) may cause the segments to appear "fractured".
11. If any fluid leaks out of a damaged glass cell, wash off any human part that comes into contact with soap and water. The toxicity is extremely low but caution should be exercised at all the time.
 12. Disassembling the LCD module can cause permanent damage and it should be strictly avoided.
 13. LCD retains the display pattern when it is applied for long time (Image retention). To prevent image retention, do not apply the fixed pattern for a long time. Image retention is not a deterioration of LCD. It will be removed after display pattern is changed.
 14. Do not use any materials, which emit gas from epoxy resin (hardener for amine) and silicone adhesive agent (dealcohol or deoxym) to prevent discoloration of polarizer due to gas.
 15. Avoid the exposure of the module to the direct sunlight or strong ultraviolet light for a long time.

The brightness of LCD module may be affected by the routing of CCFL cables due to leakage to the chassis through coupling effect. The inverter circuit needs to be designed taking the level of leakage current into consideration. Thorough evaluation is needed for LCD module and inverter built into its host equipment to ensure specified brightness.

7. MECHANICAL DRAWING

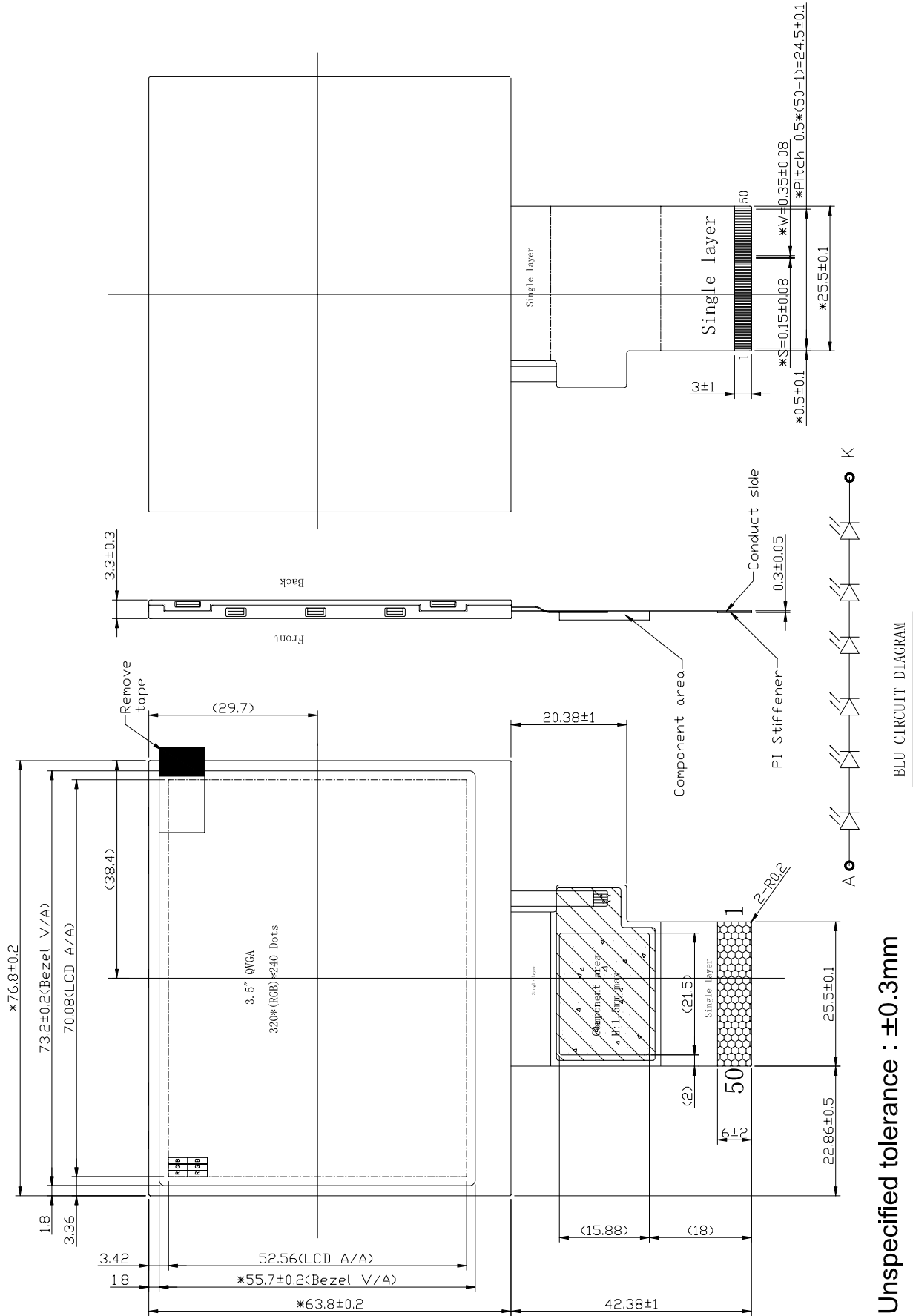

Unspecified tolerance : $\pm 0.3\text{mm}$



8. PACKAGE DRAWING
T.B.D.

9. INSPECTION SPECIFICATION

1. SCOPE SPECIFICATIONS CONTAIN

- 1.1 DISPLAY QUALITY EVALUATION
- 1.2 MECHANICS SPECIFICATION

2. SAMPLING PLAN

UNLESS THERE IS OTHER AGREEMENT, THE SAMPLING PLAN FOR INCOMING INSPECTION SHALL FOLLOW MIL-STD-105E.

- 2.1 LOT SIZE: QUANTITY PER SHIPMENT AS ONE LOT (DIFFERENT MODEL AS DIFFERENT LOT).
- 2.2 SAMPLING TYPE: NORMAL INSPECTION, SINGLE SAMPLING.
- 2.3 SAMPLING LEVEL: LEVEL II.
- 2.4 AQL: ACCEPTABLE QUALITY LEVEL
 MAJOR DEFECT: AQL=0.65
 MINOR DEFECT: AQL=1.0

3. PANEL INSPECTION CONDITION

- 3.1 ENVIRONMENT:
 ROOM TEMPERATURE: 25±5°C.
 HUMIDITY: 65±5% RH.
 ILLUMINATION: 300 ~ 700 LUX.
- 3.2 INSPECTION DISTANCE:
 35±5 CM
- 3.3 INSPECTION ANGLE:
 THE VISION OF INSPECTOR SHOULD BE PERPENDICULAR TO THE SURFACE OF THE MODULE.
- 3.4 INSPECTION TIME:
 PERCEPTIBILITY TEST TIME: 20 SECONDS MAX.

4. DISPLAY QUALITY

- 4.1 FUNCTION RELATED:
 THE FUNCTION DEFECTS OF LINE DEFECT, ABNORMAL DISPLAY, AND NO DISPLAY ARE CONSIDERED MAJOR DEFECTS.
- 4.2 BRIGHT/DARK DOTS:

| Defect Type | Specification | Major | Minor |
|----------------------------|---------------|-------|-------|
| Bright Dots | $N \leq 2$ | | ● |
| Dark Dots | $N \leq 3$ | | ● |
| Total Bright and Dark Dots | $N \leq 4$ | | ● |

Note: 1:

The definition of dot: The size of a defective dot over 1/2 of whole dot is regarded as one defective dot.

Bright dot: Dots appear bright and unchanged in size in which LCD panel is displaying under black pattern.

The bright dot defect must be visible through 2% ND filter

Dark dot: Dots appear dark and unchanged in size in which LCD panel is displaying under pure red, green, blue pattern.

4.3 Pixel Definition:

| | | | | | | | | | | | |
|---|---|---|---|---|---|---|---|---|--|---|---------------------|
| R | G | B | R | G | B | R | G | B | | ■ | Dot Defect |
| R | G | B | R | G | B | R | G | B | | ■ | Adjacent Dot Defect |
| R | G | B | R | G | B | R | G | B | | ■ | Cluster |

Note 1:

If pixel or partial sub-pixel defects exceed 50% of the affected pixel or sub-pixel area, it shall be considered as 1 defect.

Note 2:

There should be no distinct non-uniformity visible through 2% ND Filter within 2 sec inspection times.

4.4 Visual Inspection specifications:

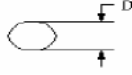
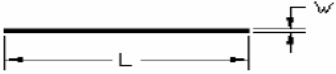
| <u>Defect Type</u> | | <u>Specification Size</u> | <u>Count(N)</u> | Major | Minor |
|--|-------------------|---|-----------------|-------|-------|
| Dot Shape (Particle · Scratch and Bubbles in display area)  | | $D \leq 0.25 \text{ mm}$ | Ignored | | • |
| | | $0.25\text{mm} < D \leq 0.5\text{mm}$ | $N \leq 3$ | | |
| | | $D > 0.5\text{mm}$ | $N=0$ | | |
| Newton Ring (Only for Touch panel) | | $D \leq 70\text{mm}$ | $N \leq 4$ | | • |
| | | $D > 70\text{mm}$ | $N=0$ | | |
| TSP Fish Eyes (Only for Touch panel) (Bubble/Dent) | | $0.1\text{mm} < D \leq 0.2\text{mm}$ | $N \leq 4$ | | • |
| | | $0.2\text{mm} < D \leq 0.3\text{mm}$ | $N \leq 3$ | | |
| | | $0.3 < D \leq 0.4$ | $N \leq 2$ | | |
| Line Shape (Particles · Scratch · Lint and Bubbles in display area)  | | $W \leq 0.01 \text{ mm}$ | Ignored | | • |
| | | $0.01\text{mm} < W \leq 0.05\text{mm}$ and $L \leq 3\text{mm}$ | $N \leq 3$ | | |
| | | $W > 0.05\text{mm}$ or $L > 3 \text{ mm}$ | $N=0$ | | |
| Bubble in cell (active area) | | It should be found by eyes | | | • |
| Bezel | Scratch | No harm | | | • |
| | Dirt | | | | • |
| | Wrap | | | | • |
| | Sunken | | | | • |
| Label | No label | No | | | • |
| | Inverted label | | | | • |
| | Broken | | | | • |
| | Dirt | Word can be read. | | | • |
| | Not clear | No | | | • |
| | Word out of shape | | | | • |
| | Mistake | | | | • |
| | Position | Be attached on right position | | | • |
| Screw | Not enough | No | | | • |
| | Limp | No | | | • |

ATM0350D18A(AZ DISPLAYS) TFT MODULE V1.0

| | | | | |
|-----------|-------------------|----------------------------|--|---|
| Connector | Connection status | No bend on pins and damage | | • |
| FPC/FFC | Broken | No | | • |

Note: Extraneous substance and scratch not affecting the display of image, for instance, extraneous substance under polarizer film but outside the display area, or scratch on metal bezel and backlight module or polarizer film outside the display area, shall not be considered as defective or non-conforming.